

# ELECTRICAL SAFETY CATALOG

---

Honeywell Salisbury 2024

---



**Honeywell**  
SALISBURY

# CONTENT

- 4** History of Salisbury
- 6** Gloves
- 20** Sleeves
- 24** Line Hoses and Covers
- 36** Blankets
- 46** Insulating Plastic Guards and Covers
- 56** Outage Protection
- 62** Arc Flash PPE
- 82** Insulated Tools
- 92** Dielectric Footwear
- 98** Grounding
- 128** Safetyline
- 152** Hotsticks
- 180** Insulators
- 184** Insulated Jumpers
- 190** Voltage Detectors



# HISTORY OF HONEYWELL SALISBURY

## PROTECTING YOUR WORKFORCE AGAINST ELECTRICAL HAZARDS

Honeywell Salisbury has been setting industry standards since 1855. For over 150 years, Honeywell Salisbury Electrical Safety and its predecessors has been the name an entire industry trusts to provide the finest safety products available.

Back in the early 1900s, Honeywell Salisbury was approached by a local utility in the Chicago area about general safety. The question raised was how to create a safer working environment for linemen working on energized lines. Honeywell Salisbury worked with the local utility company by taking garden hose and cutting them lengthwise in a way that would cover the lines. These hoses were then secured by electrical tape and this led to the Honeywell Salisbury patent of the line hose in 1924. Over the years, line hose has evolved into the high-quality SALCOR® rubber product you have come to expect.

Today, Honeywell Salisbury products are the most preferred in the Personal Electrical- Safety Protection.



- 1915** First Molded Rubber Insulating Blanket is made by W.H. Salisbury & Co.
- 1919** A rubber mill was erected to manufacture molded and extruded rubber products
- 1921** A local utility discusses linemen safety needs with W.H. Salisbury & Co. after a fatal accident occurs
- 1922** Manufacturing of full utility line of products begins
- 1922** W.H. Salisbury & Co. first perfects and begins to offer Rubber Insulating Line Hose
- 1923** W.H. Salisbury & Co. first perfects and begins to offer Insulator Hoods
- 1924** W.H. Salisbury & Co. patents Line Hose design
- 1932** W.H. Salisbury & Co. patents Rubber Insulating Sleeve design
- 1941** W.H. Salisbury & Co. patents Leather Protectors for Linemen's Rubber Gloves
- 1948** Charleston, SC factory established manufacturing insulating gloves
- 1960** W.H. Salisbury & Co. patents Protective Device design
- 1960** Addison, IL plant opens in early 1960s
- 1980** Grounding equipment, hotsticks, and insulators are added to the product line in the 1980s.
- 1999** North Hand Protection and W.H. Salisbury & Co. hand protection merge under the Salisbury name
- 2001** Arc Flash Protection garments and equipment added to the product line
- 2005** W.H. Salisbury & Co. patents Insulating Blanket design
- 2005** Company becomes Salisbury Electrical Safety, LLC
- 2006** Acquisition of North and the White Rubber Corp
- 2007** Salisbury Electrical Safety, LLC patents Rubber Insulating Blanket & Method
- 2008** Salisbury Electrical Safety, LLC becomes part of Honeywell International.
- 2017** PrismShield launches
- 2020** Pro-Wear Plus launches
- 2022** PrismShield Plus launches





# MORE DEXTERITY, MORE FREEDOM TO GET MORE DONE

## Salisbury Lineworker's Gloves

You want more from your work gloves. Increased flexibility, extra comfort — yet engineered with the same superior quality and exacting standards you've come to expect from Salisbury.

### GLOVES AT WORK

Electriflex™ is the most flexible rubber insulating glove we've ever made. Designed to give linemen the ultimate in comfort and control, these gloves minimize hand fatigue and maximize performance—all while giving you best-in-class protection. With greater flexibility and dexterity, you can optimize every part of your workday and take on tasks with less stress and strain.

Flex technology isn't just about enhancing your productivity. It's also about making sure you return home safely today and continue to lead an active, comfortable life doing the things you enjoy tomorrow.

### AMERICAN INGENUITY AT WORK

For over 150 years, Salisbury has been your trusted partner in safety and a true leader in innovation. Using the highest quality materials and small batch precision, our engineers invented a flex formula you can put to work today.



# INSULATED GLOVES

Electricity is projected to supply an increasing share of the world's total energy demand. Insulating gloves are among the most important PPE for electrical workers, they are the first line of defense for contact with any energized components or lines.

Rubber insulating gloves are recommended to be worn in conjunction with a suitable leather glove protector to provide mechanical protection from abrasion, cut, tear, and perforation.

# INSULATED LINEWORKER GLOVES

## SPECIFICATIONS AND INFORMATION

Standard specification for rubber insulating gloves  
 ASTM D120-09 EN60903:2003

ELECTRICAL SPECIFICATIONS				
Class	AC Proof Test Voltage, rms, D	DC Proof Test Voltage, avg, D	Maximum Use Voltage AC, rms, V	Maximum Use Voltage DC, avg, V
2	20000	50000	17000	25500
3	30000	60000	26500	39750
4	40000	70000	36000	54000

MATERIAL SPECIFICATIONS	
Type 1 natural rubber	Not resistant to ozone
Tensile strength	20000
Tensile strength, min	30000
Tensile stress at 200 %, max	40000
Ultimate elongation, min	600 %
Tension set, max at 400 %	15 %
Tear resistance, min	120 lbf/in (21 kN/m)
Puncture resistance, min	100 lbf/in (18 kN/m)
Hardness, shore A max	47
Accelerated aging 158 ±3.6 °F (70 ±2 °C), Circulating air, 7 days	Tensile strength and elongation of the specimen shall not be less than 80% of the original

PHYSICAL SPECIFICATIONS	
Class	Thickness: in (mm)
2	0.040 in to 0.090 in (1.02 mm to 2.29 mm)
3	0.060 in to 0.115 in (1.52 mm to 2.92 mm)
4	0.080 in to 0.140 in (2.03 mm to 3.56 mm)

ORDERING INFORMATION				
Class	Cuff Style	Length: in (mm)	Color	Sizes
NG2	Straight	14 in (356 mm), 16 in (406 mm)	B, RB, YB	7, 8, 8H, 9, 9H, 10, 10H, 11, 12
NG2	Straight	18 in (457 mm)	YB	7, 8, 8H, 9, 9H, 10, 10H, 11, 12
NG2	Bell	16 in (406 mm)	B, RB, YB	8, 8H, 9, 9H, 10, 10H, 11, 12
NG2	Contour	18 in (457 mm)	B, RB, YB	7, 8, 8H, 9, 9H, 10, 10H, 11, 12
NG3	Straight	16 in (406 mm)	B, RB, YB	7, 8, 8H, 9, 9H, 10, 10H, 11, 12
NG3	Bell	16 in (406 mm)	RB	8, 8H, 9, 9H, 10, 10H, 11, 12
NG3	Contour	18 in (457 mm)	B, RB	7, 8, 8H, 9, 9H, 10, 10H, 11, 12
NG4	Straight	16 in (406 mm)	RB	9, 9H, 10, 10H, 11, 12
NG4	Bell	16 in (406 mm)	B, RB	9, 9H, 10, 10H, 11, 12
NG4	Contour	18 in (457 mm)	B, RB	9, 9H, 10, 10H, 11, 12

High Voltage Mittens				
NG2	Bell	14 in (356 mm), 16 in (406 mm)	RB, YB	9, 10, 11
NG3	Bell	16 in (406 mm)	YB	9, 10, 11



### Glove markings

- Patch is attached to the cuff of each glove at the back of the hand
- Patch includes Salisbury, ASTM D120 compliance, size, maximum line voltage, class, type, and color coding based on class
- Serial number marked on each glove near the cuff on the thumb side for product traceability
- Electrical Test Date Mark is available upon customer request

# PROTECTIVE RUBBER EQUIPMENT LABELING CHART

## SALISBURY NATURAL RUBBER AND SALCOR® RUBBER PROTECTIVE EQUIPMENT

Rubber insulating gloves are available in six ASTM defined voltage classes. Rubber dipped sleeves are available in Class 0 through 4. The chart below identifies the class, proof test voltage and maximum allowable exposure voltage.

**Insulating Gloves and Sleeves must have a color coded label to meet appropriate ASTM**



Class	Color	Proof Test Voltage AC / DC	Max Use Voltage* AC/ DC	Insulated Rubber Glove and Sleeve Label
00	Beige	2,500 / 10,000	500 / 750	
0	Red	5,000 / 20,000	1,000 / 1,500	
1	White	10,000 / 40,000	7,500 / 11,250	
2	Yellow	20,000 / 50,000	17,000 / 25,500	
3	Green	30,000 / 60,000	26,500 / 39,750	
4	Orange	40,000 / 70,000	36,000 / 54,000	

\* When worn with leather protectors.

## RUBBER INSULATED GLOVES & MITTENS

### SALISBURY ADVANTAGE

Type I and Type II gloves are extremely flexible making it easy to work with small parts. The gloves meet or exceed ASTM D120 and IEC EN60903 Standards.

**High Voltage: ASTM Class 1, 2, 3, 4**  
**Low Voltage: ASTM Class 00, 0**

### CLASS 1 THROUGH 4 GLOVES

Class 1 through 4 gloves are available in black or in contrasting two-color combinations. The contrast between the thin outer color against the inner color makes inspecting for cuts and tears easier when the glove is inflated or stretched. Manufactured in the USA Salisbury Class 1, 2, 3, 4 gloves meet or exceed ASTM D120 and IEC EN60903 standards.

The gloves are available in Straight Cuff, Contour Cuff and Bell Cuff in 14 in (356 mm), 16 in (406 mm) and 18 in (457 mm) lengths in sizes 7 to 12 (including half sizes) and come in black, red/black and yellow/black color combinations.

### SALISBURY LINEMEN'S MITTENS

Made from the same durable lightweight rubber as the five-finger gloves, the Salisbury linemen's mittens are designed to keep the user warmer during harsh temperatures. Mittens are offered in a Bell Cuff style in Class 2 and 3, sizes 9, 10, 11 and in red/black and yellow/black color combinations.



*Accommodates heavier winter clothing and allows for greater air flow in warmer weather*

### Contour cuff



*Made with a slight angle so when you bend your arms the glove follows the angle of your elbow*

### Linemen mitten



*Keeps working hands warm during cold, harsh temperatures*

## RUBBER INSULATED GLOVES & MITTENS

### STANDARD OFFERING\*

**High Voltage: ASTM Class 1, 2, 3, 4**

HIGH VOLTAGE GLOVES				
Class	Cuff Style	Length: in (mm)	Color	Sizes
E1	Straight	14 in (356 mm), 16 in (406 mm)	B, RB, YB	7, 8, 8H, 9, 9H, 10, 10H, 11, 12
E1	Bell	14 in (356 mm)	RB	8, 8H, 9, 9H, 10, 10H, 11, 12
E1	Contour	18 in (457 mm)	RB	7, 8, 8H, 9, 9H, 10, 10H, 11, 12
E2	Straight	14 in (356 mm), 16 in (406 mm)	B, RB, YB	7, 8, 8H, 9, 9H, 10, 10H, 11, 12
E2	Straight	18 in (457 mm)	B	7, 8, 8H, 9, 9H, 10, 10H, 11, 12
E2	Bell	14 in (356 mm), 16 in (406 mm), 18 in (457 mm)	RB, YB	8, 8H, 9, 9H, 10, 10H, 11, 12
E2	Bell	16 in (406 mm)	B, YB	8, 8H, 9, 9H, 10, 10H, 11, 12
E2	Contour	18 in (457 mm)	RB, YB	7, 8, 8H, 9, 9H, 10, 10H, 11, 12
E3	Straight	14 in (356 mm)	RB	7, 8, 8H, 9, 9H, 10, 10H, 11, 12
E3	Straight	16 in (406 mm), 18 in (457 mm)	B, RB, YB	7, 8, 8H, 9, 9H, 10, 10H, 11, 12
E3	Bell	16 in (406 mm), 18 in (457 mm)	RB, YB	8, 8H, 9, 9H, 10, 10H, 11, 12
E3	Contour	18 in (457 mm)	RB, YB	7, 8, 8H, 9, 9H, 10, 10H, 11, 12
E4	Straight	16 in (406 mm), 18 in (457 mm)	B, RB, YB	9, 9H, 10, 10H, 11, 12
E4	Bell	16 in (406 mm), 18 in (457 mm)	YB	9, 9H, 10, 10H, 11, 12
E4	Contour	18 in (457 mm)	RB	9, 9H, 10, 10H, 11, 12
HIGH VOLTAGE MITTENS				
E2	Bell	14 in (356 mm), 16 in (406 mm)	RB, YB	9, 10, 11
E3	Bell	16 in (406 mm)	YB	9, 10, 11

**Low Voltage: ASTM Class 00, 0**

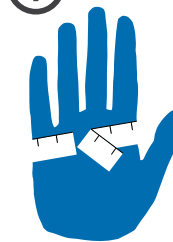

*Glove sizing – measure the circumference around the palm*



LOW VOLTAGE GLOVES				
Class	Cuff Style	Length: in (mm)	Color**	Sizes
E00	Straight	11 in (279 mm)	B, R, Y, RY, BL	7, 8, 8H, 9, 9H, 10, 10H, 11, 12
E00	Straight	14 in (356 mm)	B, R, BL	7, 8, 8H, 9, 9H, 10, 10H, 11, 12
E0	Straight	11 in (279 mm)	B, R, Y, BY, BL	7, 8, 8H, 9, 9H, 10, 10H, 11, 12
E0	Straight	14 in (356 mm)	B, R, Y, RY, BY, BL	7, 8, 8H, 9, 9H, 10, 10H, 11, 12

\* Minimum order quantities may apply to certain standard glove options.

Please contact Salisbury Customer Service for a complete minimum order quantity glove part list.

\*\* Blue gloves are EPDM gloves.

### SELECTING THE RIGHT SIZE, LENGTH AND STYLE

Salisbury linemen's gloves are available in a full range of sizes, from 7 to 12, including half sizes on 8, 9, and 10. Proper fit is important. To determine glove size, measure the circumference around the palm. Allow for additional room if fabric glove liners are to be worn, especially with thermal liners.

### SALISBURY LOW VOLTAGE CLASS 00 AND 0 GLOVES

CLASS 00 Electrical Insulating Rubber Gloves are made from red, black, or yellow Type I natural rubber. The gloves also come in blue EPDM Type II SALCOR®. The contrast between the outer orange color against the inner blue color makes inspecting for cuts and tears easier when the glove is inflated or stretched.

CLASS 0 Electrical Insulating Rubber Gloves are available in red, black, or yellow, and contrasting black/yellow colors in Type I Natural Rubber. The contrast between the outer yellow color against the inner black color makes inspecting for cuts and tears easier when the glove is inflated or stretched. These gloves are also available in blue EPDM Type II SALCOR® rubber.

Both the Class 00 and Class 0 gloves are available in 11 in (279 mm) and 14 in (356 mm) in lengths.

## PROPER INSPECTION OF INSULATED GLOVES

### SALISBURY ADVANTAGE

The G100 is a simple and easy to use, portable glove inflator. The G100 operates exactly like the G99, but includes an additional G100A adapter to also inspect Class 00 and 0 and smaller gloves. To use the adapter, the glove is secured to the G100A adapter using a nylon strap with a hook and pile closure. The adapter, with glove attached, is then placed on top of the inflator to be inflated for inspection.

### SALISBURY G100 AND G99 FOR CLASS 00 AND 0 GLOVES

OSHA 1910.137 states “Insulating equipment shall be inspected before each day’s use and immediately following any incident that can reasonably be suspected of having caused damage. Insulating gloves shall be given an air test, along with the inspection.” Salisbury’s G100 with G100A adapter for Class 00, 0 and smaller size gloves along with the G99 without an additional adapter are the perfect answer for inflating your gloves for inspection.

The G99 is a simple, easy to use, portable glove inflator. The G99 provides a quality means of inspecting gloves in the field. The glove is secured to the inflator using a nylon strap and fastened with a hook and pile closure. Inflation is accomplished by pumping the bellows of the inflator against any surface.

**Note:** gloves should be expanded no more than 1.5 times their normal size for Type I and 1.25 times their normal size for Type II SALCOR®.



## PROPER INSPECTION OF INSULATED GLOVES

### INF SERIES GLOVE INFLATORS & SLEEVE EXPANDERS

Proper safety requires frequent inspection of gloves and sleeves. These glove inflators and sleeve expanders provide an efficient way to conduct complete and thorough visual inspections before and after use in the field. They are easy to install, simple to operate, accommodate all sleeve and glove sizes and take up minimal floor space. Compressed air source required.

Item #	Description
G99	Glove inflator kit
G99B	Replacement bag
G99S	Replacement strap
G99V	Replacement check valve
G100	Glove inflator kit with adapter
G100A	Low voltage glove adapter
INF-1LV	Standard bench glove inflator (low voltage gloves)
INF-1HV	Standard bench glove inflator (high voltage gloves)
INF-2LV	Standard bench model glove inflator with air line connection (low voltage gloves)
INF-2HV	Standard bench model glove inflator with air line connection (high voltage gloves)
NF-3LV	Standard floor model glove inflator with air line connection and adjustable stand (low voltage gloves)
INF-3HV	Standard floor model glove inflator with air line connection and adjustable stand (high voltage gloves)
INF-5	Bench model air-bag inflator for high and low voltage gloves
INF-6	Standard sleeve expander
INF-7	Replacement glove inflator boots for air bag glove inflators
INF-8	Replacement bladders for sleeve expander (with closed ends); set of three
INF-9	Single replacement bladders for sleeve expander (with closed ends); outside bladder only



G99



G100



INF



G100 (with inflated low-volt glove ready for inspection)



G100A

## LEATHER PROTECTORS

All Salisbury Leather Protectors meet ASTM F696 standards.

Leather Protector Gloves should always be worn over Rubber Insulating Gloves to provide the needed mechanical protection against cuts, abrasions and punctures. Manufactured from top grade leather, all are sewn with heavy-duty nylon thread in the "gunn cut" inseam construction pattern. Each protector for Class 1-4 gloves are equipped with a nonmetallic buckle on the pull strap and an extra wide leather reinforcement over the thumb seam. Protectors for Class 00 and 0 gloves are available with non-metallic buckle and pull strap or elastic wrist.

It is the responsibility of the purchaser to specify the overall length of the protector gloves. The Clearance Table below shows the minimum distance which shall be allowed between the protector glove cuff and the bead of the rubber glove per ASTM F496 Specifications.

Proper care of leather protectors is essential to user safety. Inspect the leather protectors when inspecting rubber gloves for common problems such as cracking and cutting, chemical attaching, folding, snags, etc that result from metal particles, embedded wire, abrasive materials or any substance that could physically damage the rubber gloves.

### ⚠ WARNING

Do not use leather protectors alone for protection against electric shock. Serious injury or death will result. Always use a properly rated insulating glove for the voltage being worked.

### CLEARANCE FOR LEATHER PROTECTORS PER ASTM F496

Class / Color	Minimum Distance Between Protector Cuff and Glove in (mm)
00	0.5 in (13 mm)
0	0.5 in (13 mm)
1	1 in (25 mm)
2	2 in (51 mm)
3	3 in (75 mm)
4	4 in (102 mm)



Minimum distance from the leather protector cuff to the bead of the rubber glove for this Class 2 glove is 2 in (51 mm).



**i** Glove sizing – measure the circumference around the palm

## NEXT GENERATION LEATHER PROTECTORS

Next Generation Leather Protectors are manufactured from top-grade cowhide and goatskin leather. Protectors are crafted using heavy-duty, 4-ply cotton thread and are equipped with a nonmetallic buckle for a secure fit.

### COMFORT AND DEXTERITY

Honeywell Salisbury is proud to introduce the Next Generation Leather Protector which is designed exclusively for the insulated Electriflex™ rubber gloves. These new leather protectors offer utility workers the comfort and dexterity needed to get the job done. Next Generation Leather Protectors are available in a variety of whole and half sizes in three different lengths: 12 in (305 mm), 14 in (355 mm) and 16 in (406 mm). The redesigned leather protector was constructed to help amplify the flexibility of the Electriflex™ gloves.

### Our leather protectors offer:

- Clute design for a more customized fit with Electriflex™
- Premium-grade leather
- Durable cowhide cuff for tough working conditions
- Goatskin hand protection to ensure comfort, flexibility and better dexterity

### NEXT GENERATION LEATHER PROTECTORS

Item #	Cuff Style	Length in (mm)	Weight Each lb (kg)	Sizes
NGILP3S	Straight	12 in (305 mm)	0.50 (0.23)	8, 8.5, 9, 9.5, 10, 10.5, 11, 12
NGILP5S	Straight	14 in (355 mm)	0.62 (0.28)	8, 8.5, 9, 9.5, 10, 10.5, 11, 12
NGILP7S	Straight	16 in (406 mm)	0.76 (0.34)	8, 8.5, 9, 9.5, 10, 10.5, 11, 12

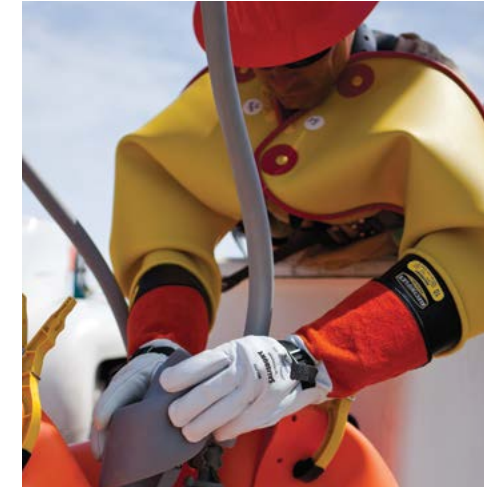



## LEATHER PROTECTORS

### SALISBURY'S SALCOR® CUFF PROVIDES MAXIMUM PROTECTION

#### 156 PREMIUM SERIES

These protectors are made from specially tanned Grade A Red Boulevard buffed leather and an orange colored SALCOR® "Super Cuff" in the 4 in (102 mm) and 6 in (152 mm) cuff lengths. The "Super Cuff" has different characteristics than leather or vinyl cuffs; it does not absorb water, has greater track resistance and creepage.

Item #	Cuff Style	Cuff Length in (mm)	Overall Length in (mm)	Weight Each lb (kg)	Sizes
156-4	Straight	4 in (102 mm)	12 in (305 mm)	1 lb (0.5 kg)	8/8.5, 9/9.5, 10/10.5, 11/11.5, 12
156-6	Straight	6 in (152 mm)	14 in (355 mm)	1.2 lb (0.5 kg)	8/8.5, 9/9.5, 10/10.5, 11/11.5, 12

#### ILP SERIES

Manufactured from top-grain cowhide or goatskin, these protectors provide excellent protection for rubber insulating gloves at an economical price. Cowhide cuffs are tough leather on palm side and orange vinyl on the back, while the goatskin cuffs are green leather on palm side and orange vinyl on back. A full offering of styles is available from 10 in (254 mm) to 16 in (406 mm) contour cuff. Leather protectors are available in size 7, dual sizes 8/8.5 through 11/11.5 and size 12.

#### ILPM SERIES MITTEN PROTECTOR

Manufactured from top-grain cowhide, these protectors offer excellent comfort and protection. The ILPM Series mitten protectors feature adjustable straps with non-metallic buckles and are stitched with polyester thread for strong seams. Cuffs are tough leather on palm side and orange vinyl on the back of the hand. Leather protectors are available in sizes 9, 10 and 11..

ILP SERIES GLOVES, COWHIDE*		
Item #	Length: in (mm)	Sizes
ILP3S	12 in (305 mm)	7, 8/8.5, 9/9.5, 10/10.5, 11/11.5, 12
ILP4S	13 in (330 mm)	7, 8/8.5, 9/9.5, 10/10.5, 11/11.5, 12
ILP5S	14 in (356 mm)	7, 8/8.5, 9/9.5, 10/10.5, 11/11.5, 12
ILP6S	15 in (381 mm)	8/8.5, 9/9.5, 10/10.5, 11/11.5, 12
ILP7C	16 in (406 mm)	8/8.5, 9/9.5, 10/10.5, 11/11.5, 12
ILP10	10 in (254 mm)	7, 8/8.5, 9/9.5, 10/10.5, 11/11.5, 12
ILP10A	10 in (254 mm)	7, 8/8.5, 9/9.5, 10/10.5, 11/11.5, 12

ILPM SERIES MITTENS, COWHIDE*			
Item #	Length: in (mm)	Weight Each: lb (kg)	Sizes
ILPM3S	12 in (305 mm)	1 lb (0.5 kg)	9, 10, 11
ILPM4S	13 in (330 mm)	1 lb (0.5 kg)	9, 10, 11
ILPM5S	14 in (356 mm)	1.2 lb (0.5 kg)	9, 10, 11

\*To specify goatskin, use ILPG. Goatskin not available in size 7.



156-4

156-6



ILP3S

ILP7C



ILPG10

ILP10A

ILPM5S

## GLOVE STORAGE & GLOVE KITS

### SALISBURY ADVANTAGE

Salisbury's insulating rubber gloves are necessary for every electrical worker's complete safety. To ensure your safety, Salisbury's leather protectors provide needed protection from cuts, abrasions and punctures. To keep these safety items in top condition, proper storage is very important.

GLOVE KITS				
Catalog Prefix	Class	Length: in (mm)	Color	Glove Size
GK	00	11 in (280 mm) or 14 in (356)	B, BL, Y, R	7, 8, 8H, 9, 9H, 10, 10H, 11, 12
GK	0	11 in (280 mm) or 14 in (356)	B, BL, Y, R	7, 8, 8H, 9, 9H, 10, 10H, 11, 12
GK	2	14 in (356 mm), 16 in (406 mm) or 18 in (457 mm)	B, RB	7, 8, 8H, 9, 9H, 10, 10H, 11, 12

#### Glove kit numbering system sample: GK011BL9

GK    0    11                                BL            9  
 Glove kit    Class 0    Length: 11 in (280 mm)    Color: Blue    Glove size: 9

The appropriate glove bag and leather protectors will be included.  
 Type I Natural Rubber available in: R=Red, Y=Yellow, B=Black, RB=Red in, Black out  
 Type II Salcor® Rubber available in: BL=Blue

#### STORAGE

Proper storage extends the service life of linemen's gloves. Folds and creases strain rubber and cause it to crack from ozone exposure prematurely. By storing rubber gloves in the right size bag, and never forcing more than one pair into each bag, equipment will lie flat and last longer.

Salisbury bags are constructed of heavy duty canvas duck, are double stitched, and riveted at stress points for extra durability. Canvas bags feature a D ring for hanging in trucks or on work belts. Bags feature tapered gussets with wide opening tops for easy insertion.

Glove and Protector Combo Bags contain two layered pockets in one bag. Now, both a pair of gloves and protectors can be properly stored in one convenient bag. Never worry about having to bring more than one bag from job site to job site.

26 OZ CANVAS GLOVE BAGS			
Item #	Glove Length: in (mm)	Bag Dimensions: in (mm)	Weight Each: lb (kg)
GB112	11 in (280 mm)	9 in x 14 in (229 mm x 356 mm)	1 lb (0.5 kg)
GB114	14 in (356 mm)	9 in x 16 in (229 mm x 406 mm)	1 lb (0.5 kg)
GB116	16 in (406 mm)	9 in x 18 in (229 mm x 457 mm)	1.2 lb (0.6 kg)
GB118	18 in (457 mm)	9 in x 20 in (229 mm x 508 mm)	1.5 lb (0.7 kg)
14.75 OZ CANVAS GLOVE & PROTECTOR BAGS			
Item #	Glove Length: in (mm)	Bag Dimensions: in (mm)	Weight Each: lb (kg)
GPB112	12 in (305 mm)	9 in x 14 in (229 mm x 356 mm)	1 lb (0.5 kg)
GPB114	14 in (356 mm)	9 in x 16 in (229 mm x 406 mm)	1 lb (0.5 kg)
GPB116	16 in (406 mm)	9 in x 18 in (229 mm x 457 mm)	1.2 lb (0.6 kg)
GPB118	18 in (457 mm)	9 in x 20 in (229 mm x 508 mm)	1.5 lb (0.7 kg)
GLOVE & SLEEVE COMBO BAGS			
Item #	Glove Length: in (mm)	Bag Dimensions: in (mm)	Weight Each: lb (kg)
2C16	14 in (356 mm), 16 in (406 mm)	9 in x 18 in (229 mm x 457 mm)	1.2 lb (0.6 kg)
2C18	18 in (457 mm)	9 in x 20 in (229 mm x 508 mm)	1.5 lb (0.7 kg)

Glove kit



GK011R/10

Canvas glove bag



GB116

Canvas glove & protector bag



GPB116



**i** Combo bags contain two layered pockets in one bag

## LINEMEN'S GLOVE LINERS

Enhance the comfort of wearing rubber insulating gloves and mittens in every season with linemen's glove liners. Salisbury's liners provide warmth in the cold season and absorb perspiration in the warm months. Many styles and fabrics are available with either an open or knit wrist. The glove liners are made from stretch fabric that can fit any hand size.

### STYLES AND FABRICS

The L Series has a tough outer cotton fabric while the inner lining is soft and comfortable while the LMKC Series is light, airy and allows ease of movement. The LMKW Series is made from a wool blend fabric that moves easily yet gives a substantial layer of lining.

The 89 Series is Salisbury's classic summer and winter glove liner. Liners absorb perspiration from hands. The summer liner is white in color and 100% cotton. The winter blend is made of 85% acrylic, 15% nylon and is a rust color.

LINEMEN'S GLOVE LINERS*				
Item #	Description	Wrist Style	Length in (mm)	Weight Each lb (kg)
L10JK	Jersey style, lightweight, seams out	Knit	10 in (254 mm)	0.14 lb (0.06 kg)
L10J	Jersey style, lightweight, seams out	Open	10 in (254 mm)	0.12 lb (0.06 kg)
L12J	Jersey style, lightweight, seams out	Open	12 in (305 mm)	0.14 lb (0.06 kg)
L10MKC	Machine knit, 100% cotton	Knit	10 in (254 mm)	0.12 lb (0.05 kg)
L12MKC	Machine knit, 100% cotton	Knit	12 in (305 mm)	0.12 lb (0.05 kg)
L10MKW	Machine knit, wool blend	Knit	10 in (254 mm)	0.14 lb (0.06 kg)
L12MKW	Machine knit, wool blend	Knit	12 in (305 mm)	0.14 lb (0.06 kg)
89/1402	White machine knit, 100% cotton	Knit	10 in (254 mm)	0.12 lb (0.06 kg)
89/4702	Rust machine knit, 85% acrylic and 15% nylon	Knit	10 in (254 mm)	0.12 lb (0.06 kg)

\* One size fits all.



L10J



L10K



L12J



L12MKC

L10MKW



89/1402

89/4702

## CLEANERS & SUPPLIES

### RUB-OUT®

A non-petroleum-based hand cleaner for workers who wear rubber gloves and sleeves, Rub-Out® dissolves and removes grease, oil, ink, tar, pipe dope, creosote, paint and more without harming natural rubber or SALCOR® rubber. Product cleans with or without water and contains skin conditioners that leave a fresh citrus scent.

### RUB-OUT® TOWELETTES

Pre-moistened, heavy duty hand cleaner towels that work fast to loosen, dissolve, and absorb dirt and grease, and will not harm rubber gloves! Our powerful yet safe cleaning agents work together with an absorbent, non-scratching abrasive cleaning towel. The citrus-based formula easily removes soil from your hands and leaves them cleaned and conditioned anywhere you're working. And after cleaning your hands, there is enough absorbency to clean your tools and other surfaces with the same towel. These shop size 10.5 in x 12.25 in (267 mm x 311 mm) durable towels quickly remove tough-to-clean substances including lubricants, tar, oils, wax, caulk and much more.

### TEN-FOUR® GLOVE DUST

A cooling, frictionless dust that absorbs moisture and perspiration when wearing rubber gloves. Provides extra comfort while preventing gloves from getting sticky. The 5 oz (0.14 kg) bottle easily fits in a pocket or glove bag. The 4 qt (3.8 l) bulk package is used in test labs as a dusting powder when cleaning and testing.

### SUPER SALCOR® DETERGENT

A concentrated detergent with a special grease release formula that removes oils, grease and dirt from natural rubber and SALCOR® rubber equipment. Suitable for washing linemen's rubber gloves, sleeves and other specialty equipment by hand or in commercial washing machines. Also works well on fiberglass and other materials. Just dilute with water, apply with a rag or sponge, and rinse thoroughly.

### SALCON® SILICONE SPRAY

Specially formulated spray to reduce friction on SALCOR® only. Forms an oxygen barrier which helps reduce corona cutting and weather checking on rubber equipment. May also be used to spray spark plugs and battery terminals in damp weather to assist in starting.

Item #	Description	Weight Each lb (kg)
1451	Rub-out® hand cleaner; 16 oz (0.45 kg) can; 12/pack	16 lb (7.3 kg)
1453	Rub-out® hand cleaner dispenser for 4.5 lb (2 kg) can	1 lb (0.5 kg)
1460	Rub-out® Towelettes; bucket of 60; 6 buckets/case	14 lb (6.4 kg)
1461	Rub-out® Towelettes; single packets; 100/case	3 lb (1.4 kg)
10-4	Ten-Four® glove dust; 5 oz (0.14 kg) squeeze bottle; 12/pack	5.5 lb (2.2 kg)
10-4-4QT	Ten-Four® glove dust; 4 qt (3.8 l) bulk; 1/pack	8 lb (3.6 kg)
S4	Super SALCOR® detergent; 1 gal (3.8 l) jugs; 4/pack	54 lb (24.5 kg)
S5	Super SALCOR® detergent; 5 gal (19 l) drum	49 lb (22.3 kg)
S55	Super SALCOR® detergent; 55 gal (208 l) drum	540 lb (245 kg)
S99	SALCON® silicone spray, 16 oz (0.45 kg) aerosol can	



1451



1460



1461



10-4



S5



S99



# OUTSTANDING PROTECTION, SUPERIOR PERFORMANCE

## Salisbury Lineworker's Sleeves

The styles you want and the protection you need come together in Salisbury lineworker's sleeves. Two different processes are used to manufacture our insulating sleeves. Both the dipped and molded sleeves meet the current requirements of ASTM D1051

and offer the same high level of quality and protection. The sleeves feature a reinforcing fold at the cuff which is preferred over a rolled bead because it adds less bulk to the cuff and fits into the glove easier without pushing.

### SIZING

Sleeves should be selected to fit the arm comfortably from the top of the shoulder to inside the top of the glove. To minimize the possibility of the sleeves pushing gloves off the hand, size the sleeve to the shortest length possible while maintaining complete coverage to the shoulder.

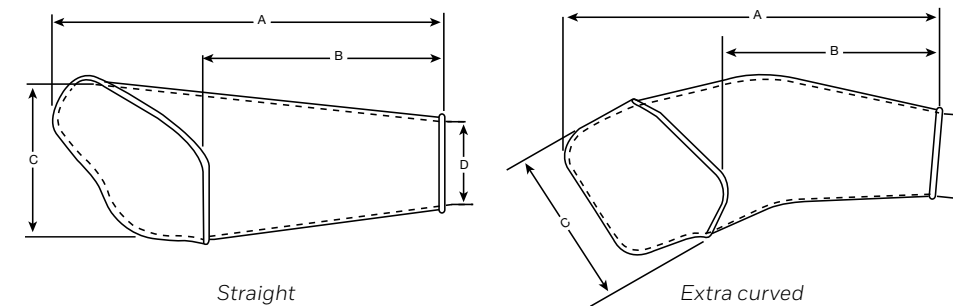

# LINEMEN'S SLEEVES

More utilities are requiring the use of sleeves in the workplace. Rubber Insulating Sleeves extend coverage of the arm from the cuff of rubber insulating gloves to the shoulder creating full protection of these areas from accidental contact with energized conductors and equipment. Salisbury offers high-quality dipped linemen's sleeves as well as molded sleeves.

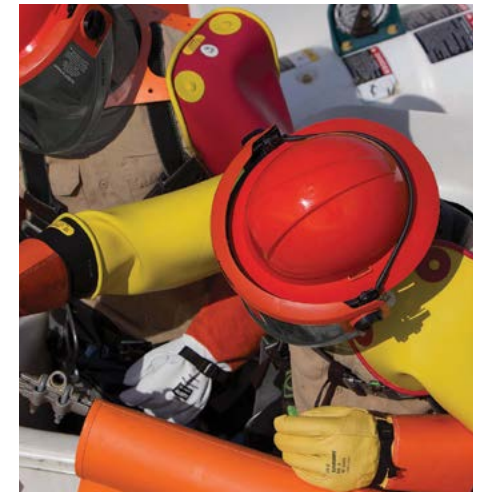

STRAIGHT ARM SLEEVE				
Size	Dimensions: in (mm)			
	A	B	C	D
Small	24.25 in (616 mm)	15.13 in (384 mm)	12.5 in (317 mm)	5.75 in (146 mm)
Regular	26.25 in (667 mm)	15.5 in (394 mm)	11.25 in (286 mm)	5.5 in (140 mm)
Large	28.5 in (724 mm)	17 in (432 mm)	12.87 in (327 mm)	6.87 in (175 mm)
Extra Large	30 in (762 mm)	19 in (483 mm)	13.25 in (337 mm)	6.87 in (175 mm)

EXTRA CURVED ARM SLEEVE				
Size	Dimensions: in (mm)			
	A	B	C	D
Small	24.25 in (616 mm)	15.13 in (384 mm)	12.5 in (317 mm)	5.75 in (146 mm)
Regular	26.5 in (673 mm)	15.5 in (394 mm)	12.25 in (311 mm)	5.25 in (133 mm)
Large	27.75 in (705 mm)	16 in (406 mm)	12.87 in (327 mm)	6.87 in (175 mm)
Extra Large	29.5 in (749 mm)	17.5 in (445 mm)	12.87 in (327 mm)	7 in (178 mm)

## LINEMEN'S SLEEVES

### SALISBURY ADVANTAGE

Salisbury offers both dipped and molded sleeves.

### DIPPED SLEEVES

Dipped sleeves are manufactured in the same way as Salisbury rubber insulating gloves. Porcelain forms are dipped into liquefied rubber, dried, trimmed, marked and cured. Every sleeve receives the same quality inspections and electrical testing before shipping.

#### DIPPED TYPE I SLEEVES

Class	Size	Color
D0	S (small); R (regular); L (large); XL (extra-large)	Y
D1	S (small); R (regular); L (large); XL (extra-large)	B
D2	S (small); R (regular); L (large); XL (extra-large)	YB (Y inside, B outside)
D3	S (small); R (regular); L (large); XL (extra-large)	RB (R inside, B outside)
D4	S (small); R (regular); L (large); XL (extra-large)	YR (Y inside, R outside)

Add suffix "-ST" to order straight cuff or "-EC" to order extra-curved cuff  
Example: **D2LYB-ST** is a Class D, large, yellow inside, black outside, straight cuff dipped sleeve

### MOLDED SLEEVES

Molded sleeves, with a preferred and familiar fit, are manufactured by the compression molding method. The advantage of this method is the ability to produce sleeves that provide the same high quality and electrical protection as natural rubber, with the added benefit of being resistant to ozone and ultraviolet radiation. Type I sleeves are available in black, yellow or maroon and are available in curved arm style.

#### MOLDED TYPE I SLEEVES

Class	Size	Color
1	R (regular); L (large)	Y
2	R (regular); L (large); XL (extra-large)	B, Y, M
3	R (regular); L (large)	Y, M
4	R (regular); L (large)	M

Example: **2RB** is a Class 2, regular, black molded sleeve

Straight arm



D2RY B-ST

Extra-curved arm



D2RY B-ST

Molded black Type I



2RB

Molded yellow Type I



3LY

#### **i** Dipped and Molded Sleeves Color Key

- Y Yellow
- B Black
- R Red
- M Maroon

## SLEEVE STORAGE & ACCESSORIES

### SALISBURY ADVANTAGE

The T32 bag contains a **crush resistant lining** to create a more protective environment for your sleeves.

### PROPER STORAGE EXTENDS LIFE

Folds and creases strain rubber and cause it to prematurely crack from ozone. By storing rubber sleeves in the right size bag, and never forcing more than one pair into each bag, equipment will lie flat and extend the life of the product.

Salisbury bags are constructed of heavy-duty canvas duck, double stitched, and riveted at stress points for extra durability. Canvas bags feature a D-ring for hanging in trucks or on work belts. Bags feature tapered gussets with wide opening tops for easy insertion.

### INF SERIES SLEEVE EXPANDERS

Proper safety requires frequent inspection of gloves and sleeves. These sleeve expanders provide an efficient way to conduct complete and thorough visual inspections before and after use in the field. They are easy to install, simple to operate, accommodate all sleeve sizes and take up minimal floor space. Compressed air source required.

**Note:** refer to page 9 of the Gloves section to see the INF series glove inflators.

### ACCESSORIES

Sleeve buttons, straps and harnesses are required to wear rubber insulating sleeves properly. Four buttons, two straps or one harness is required per pair of sleeves.

Item #	Accessory	Description	Weight Each lb (kg)
T31	Canvas sleeve bag	30 × 9.5 in (762 × 241 mm)	1.5 lb (0.7 kg)
T32	Canvas sleeve bag	30 × 13 in (762 × 330 mm)	3 lb (1.4 kg)
INF-6	Expander	Standard sleeve expander	
INF-8	Replacement bladder	(3) Replacement bladders for sleeve expander (with closed ends)	
INF-9	Replacement bladder	(1) Replacement bladder for sleeve expander (with closed ends); outside bladder only	
B2	Buttons	One-piece sleeve button	0.2 lb (0.01 kg)
B22	Buttons	Four screw type buttons	0.8 lb (0.04 kg)
S1	Straps	(2) 15 in (381 mm) straps with four B2 buttons	0.1 lb (0.005 kg)
S1NB	Straps	(2) 15 in (381 mm) straps	0.1 lb (0.005 kg)
H1	Harness	Harness with four B2 buttons	1 lb (0.45 kg)



T31

T32

Detail of D ring on back



INF



B2 (One-piece sleeve button; two required per pair of sleeves)



B22 (Two-piece sleeve button; four required per pair of sleeves)



S1



H1



# TOP LINE SAFETY THAT WITHSTANDS THE ELEMENTS

## Salisbury Line Hose Products\*

Keeping your workers safe is your top priority. With over a hundred years of research and development on lineworker's protective equipment, Salisbury offers insulating line hose products made with their patented SALCOR® Rubber for maximum protection.

### LINE HOSE SIZING CHART

The connector, formed at one end of the line hose, receives and overlaps the end of an adjoining hose for a distance of 6.5 in (165 mm). For the correct line hose, determine the maximum conductor diameter recommended for use with each size hose. For ease of installation and to minimize the potential of flashover through the overlapping lips, line hose is always sized larger than the maximum conductor diameter. Use the chart below to determine the correct line hose which is available in four ASTM D1050 styles.



**Style A**

Class 2 & 3, straight conventional

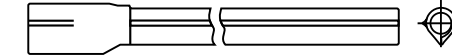

**Style B**

Class 2 & 3, connector end conventional



**Style C**

Class 4, straight extended lip

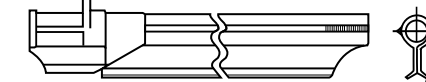

**Style D**

Class 4, extended lip connector end

LINE HOSE SELECTOR								
Line Hose I.D. in (mm)	Conductors and Diameters in (mm)							
	4/0 0.46 in (12 mm)	266,800 0.609 in (15.5 mm)	336,400 0.677 in (17 mm)	477,000 0.793 in (20 mm)	556,500 0.858 in (22 mm)	795,000 1.028 in (26 mm)	954,000 1.126 in (29 mm)	1,351,500 1.34 in (35 mm)
1 in (25 mm)	20 kV Conventional							
1.25 in (31 mm)	20 kV Conventional							
1.5 in (38 mm)	30 kV Conventional							
1.5 in (38 mm)	40 kV SU System							
2 in (51 mm)	30 kV Conventional							
2 in (51 mm)	40 kV SU System							
2.5 in (64 mm)	30 kV Conventional							
2.5 in (64 mm)	40 kV SU System							

\* All Salisbury covers and protective equipment are designed for personal protection only. They are not to be used for mechanical protection.

# LINE HOSE & COVERS

Using properly maintained insulating line hoses on energized power lines is a safe practice to prevent line workers from accidentally encountering live parts and significantly decreasing the risk of electrical accidents. The insulating line hoses cover the wire conductors and prevent them from coming in contact with each other, tools, or line workers. Salisbury uses SALCOR® Rubber to produce their line hose products for superior protection and top performance.

### ADVANTAGES OF SALCOR® RUBBER

Exclusive SALCOR® Type II Rubber is the preferred material for our insulating line hose products.

#### Why:

- Remains flexible in cold weather
- Resistant to ozone and UV rays
- Withstands the elements and maintains insulating properties



## LINE HOSE & CONNECTORS CONVENTIONAL SYSTEM

The Conventional Style Line Hose is available in orange Type II SALCOR® which remains flexible even in cold weather and is not damaged by ozone or ultraviolet rays. Each line hose has Salisbury's RIB-GRIP® Locking System. The straight or connector end style is available in three sizes: 1 in and 1.25 in I.D. rated at 17 kV, Class 2 and 1.5 in I.D. rated at 26.5 kV, Class 3. Straight style SALCOR® hose is also available in 2 in or 2.5 in I.D. rated at Class 3.

### Conventional line hose connectors

- Made from Type II orange SALCOR®
- Can be used on 1 in, 1.25 in, or 1.5 in I.D. conventional line hose
- Use the SU-ES System Connector to connect 2 in and 2.5 in I.D. conventional line hose

### BREAKTHROUGH IN LINeworker PROTECTION

The self-locking lip, that Salisbury patented, prevents the line hose from coming off the conductor after an installation is complete. Often when a lineworker is working on an installation and making adjustments, the angle of connection shifts causing line hose and covers to separate. To prevent this, Salisbury developed an ingenious solution for ensuring that any two protective devices would hold together yet still be easy for a lineworker to assemble and take apart.

### RIB-GRIP® LOCKING SYSTEM

The RIB-GRIP® construction takes advantage of rubber's natural tendency to grip and tighten its grip through compression. By creating curving rib configurations slit at a specific angle, two pieces easily slip together but resist coming apart. To quickly disengage the lineworker needs only to compress the rubber on either side.



#### RIB-GRIP® FEATURES

	Sectional view of typical insulator cover showing arrangement of ribs. Ribs are engineered to grip the serrations on its corresponding line hose, regardless of angle.
	A row of serrations on both sides of connector line hose grips snugly inside the large arm of insulator covers.
	Saw-tooth serrations on the ends of line hose are angled to make it easy to insert, but resist coming apart.
	Connector end line hose with rubber ribs grasp tightly and hold an adjoining length of hose.



## LINE HOSE & CONNECTORS CONVENTIONAL SYSTEM

### ALL LINE HOSE COMPLIES WITH CURRENT ASTM D1050 SPECIFICATIONS

SALCOR® STRAIGHT LINE HOSE, TYPE II				
Item #	Color	ASTM Class	Dimensions: I.D. × Length	Weight Each lb (kg)
			in × ft (mm)	
OR100-3-ES	Orange	2	1 in × 3 ft (25 mm × 915 mm)	3 lb (1.4 kg)
OR100-45-ES	Orange	2	1 in × 4.5 ft (25 mm × 1372 mm)	4 lb (1.8 kg)
OR100-6-ES	Orange	2	1 in × 6 ft (25 mm × 1820 mm)	5.5 lb (2.5 kg)
WR100-6-ES	White	2	1 in × 6 ft (25 mm × 1820 mm)	5.5 lb (2.5 kg)
OR125-3-ES	Orange	2	1.25 in × 3 ft (31.5 mm × 915 mm)	4 lb (1.8 kg)
OR125-45-ES	Orange	2	1.25 in × 4.5 ft (31.5 mm × 1372 mm)	6 lb (2.7 kg)
OR125-6-ES	Orange	2	1.25 in × 6 ft (31.5 mm × 1820 mm)	7.5 lb (3.4 kg)
OR150-3-ES	Orange	3	1.5 in × 3 ft (40 mm × 915 mm)	5 lb (2.3 kg)
OR150-45-ES	Orange	3	1.5 in × 4.5 ft (40 mm × 1372 mm)	7 lb (3.2 kg)
OR150-6-ES	Orange	3	1.5 in × 6 ft (40 mm × 1820 mm)	9.5 lb (4.3 kg)
OR200-3-ES	Orange	3	2 in × 3 ft (50 mm × 915 mm)	5.5 lb (2.5 kg)
OR200-6-ES	Orange	3	2 in × 6 ft (50 mm × 1820 mm)	11 lb (5 kg)
OR250-6-ES	Orange	3	2.5 in × 6 ft (63 mm × 1820 mm)	14 lb (6.4 kg)
SALCOR® CONNECTOR END LINE HOSE, TYPE II				
OR100-3C-ES	Orange	2	1 in × 3 ft (25 mm × 915 mm)	3.5 lb (1.6 kg)
OR100-45C-ES	Orange	2	1 in × 4.5 ft (25 mm × 1372 mm)	5 lb (2.3 kg)
OR100-6C-ES	Orange	2	1 in × 6 ft (25 mm × 1820 mm)	6.5 lb (2.9 kg)
OR125-3C-ES	Orange	2	1.25 in × 3 ft (31.5 mm × 915 mm)	4.5 lb (2 kg)
OR125-6C-ES	Orange	2	1.25 in × 6 ft (31.5 mm × 1820 mm)	7 lb (3.2 kg)
OR150-3C-ES	Orange	3	1.5 in × 3 ft (40 mm × 915 mm)	6 lb (2.7 kg)
OR150-4C-ES	Orange	3	1.5 in × 4 ft (38 mm × 1219 mm)	
OR150-45C-ES	Orange	3	1.5 in × 4.5 ft (40 mm × 1372 mm)	8 lb (3.6 kg)
OR150-6C-ES	Orange	3	1.5 in × 6 ft (40 mm × 1820 mm)	9 lb (4.1 kg)
LINE HOSE CONNECTORS, TYPE II				
ORC100-ES	Orange	2	1 in × 1 ft (25.4 mm × 305 mm)	2.5 lb (1.1 kg)
ORC125-ES	Orange	2	1.25 in × 1 ft (32 mm × 305 mm)	3.5 lb (1.6 kg)
ORC150-ES	Orange	3	1.5 in × 1 ft (38 mm × 305 mm)	3 lb (1.4 kg)



## LINE PROTECTORS & COVERS CONVENTIONAL SYSTEM

### INSULATOR COVERS

Orange weather-resistant Type II SALCOR® Insulator Covers are used with conventional line hose to cover pin-type insulators. All covers feature RIB-GRIP® construction to lock to the underside of the insulators. The large diameter arm overlaps the small arm of the adjoining cover on double arm constructions which provides complete insulation at the joint regardless of the varying distance between pins.

### DEAD END PROTECTORS

Dead End Protectors cover 4.25 in and 6 in bells or polymer insulators with a skirt diameter of less than 6 in. The protectors are made from orange, Type II SALCOR® with RIB-GRIP® construction. OR101-ES has outer ribs that allow it to be used with 2 in and 2.5 in I.D. Conventional Line Hose when using the UC2-ES connector. The smaller OR114-ES may also be used to cover transformer bushings up to a 4.75 in diameter. OR124-ES can cover polymer insulators up to a 4.75 in diameter and 25 in overall length including hardware. Replacement Straps are available.

### CROSS ARM COVERS

To work on live lines safely, conductors encased in a line hose should never be placed directly on a cross arm. Cross arm covers reduce electrical stresses on line hose or jumpers and fit standard cross arm pin spacing. Each unit has interior ribs to minimize shifting on the arm.

### CUTOUT COVERS

Flexible Cutout Covers can be used for overhead cutouts as well as for underground pad-mount applications. Cutout Covers comply with the current ASTM D1049 specifications.



## LINE PROTECTORS & COVERS CONVENTIONAL SYSTEM

### ALL COVERS COMPLY WITH CURRENT ASTM D1049 SPECIFICATIONS

#### DEAD END PROTECTORS, TYPE II

Item #	Class	Use With		Overall Dimensions in (mm)	Weight Each lb (kg)
		Bell Size in (mm)	Line Hose Size in (mm)		
OR101-ES	2	2 in to 6 in (51 mm to 152 mm)	1 in (25 mm)	6.5 in × 23 in (165 mm × 584 mm)	10 lb (4.6 kg)
OR114-ES	3	1 in to 4.25 in (25 mm to 108 mm)	1.5 in (38 mm)	4.75 in × 14 in (121 mm × 356 mm)	4 lb (1.8 kg)
OR124-ES	3	2 in to 4.25 in (51 mm to 108 mm)	1.5 in (38 mm)	4.75 in × 29 in (121 mm × 737 mm)	7.5 lb (3.4 kg)

#### CROSS ARM COVERS, TYPE II

Item #	Class	Use on Cross Arms, Maximum Size in (mm)	Overall Dimensions in (mm)	Weight Each lb (kg)
145-ES	2	4 in × 4.5 in (102 mm × 114 mm)	14.5 in × 4.63 in × 4.15 in (368 mm × 117 mm × 105 mm)	3 lb (1.4 kg)
1186-ES	4	5.5 in × 6 in (140 mm × 152 mm)	17 in × 6 in × 5.5 in (432 mm × 152 mm × 140 mm)	5 lb (2.3 kg)

#### CUTOUT COVERS, TYPE II

CC24-ES	2	—	24 in × 15 in × 3.5 in (600 mm × 376 mm × 88 mm)	5 lb (2.3 kg)
CC30-ES	4	—	30 in × 20 in × 7 in (750 mm × 500 mm × 175 mm)	10 lb (4.5 kg)

#### REPLACEMENT STRAPS, TYPE II

Item #	Description	Overall Dimensions in (mm)	Weight Each oz (g)
N24-ES	Use with 114 and 124 Series	0.75 in × 30 in (18 mm × 588 mm)	2 oz (56.7 g)
N36-ES	Use with 101 Series	0.75 in × 36 in (18 mm × 882 in)	2 oz (56.7 g)



**i** Salisbury's insulator covers are easy to put on and remove

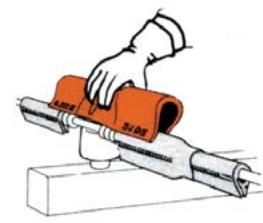
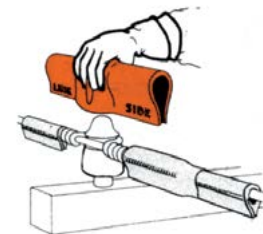

Put on with a firm downward pressure.

Remove by "rolling off" sideways.

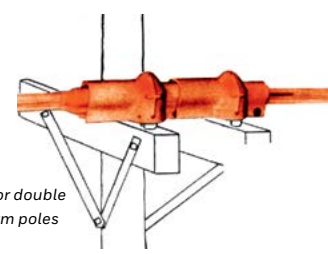
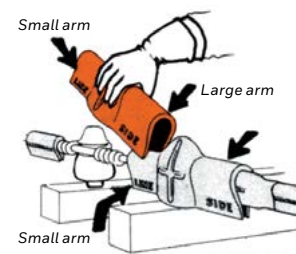

Attaching the hoods to opposite insulators on double arms.

The larger extending arm of one hood fits easily over the small arm of the opposite insulator hood.

## LINE HOSE EXTENDED LIP SU SYSTEM

The Extended LIP SU-ES System is the only complete flexible cover-up available for use on voltages through 34.5 kV. Extremely versatile, it may be installed by hand, wearing rubber insulating gloves, from an insulated aerial device or platform, or with hot sticks using the SU-ES applicators. Manufactured from superior SALCOR® Type II elastomer, it is resistant to the effects of ozone and ultraviolet deterioration. It remains flexible even at sub-zero temperatures.

Salisbury's RIB-GRIP® construction securely interlocks with its corresponding covers and connectors. Tapered lips facilitate easy starting on the conductors. The contour cut ends accommodate the skirts of pin type insulators and permit the hose to cover the line snug to a saddle or clamp.

### STRAIGHT LINE HOSE

Available as Straight Line Hose or with a Connector End for easier connection of line hose and covers. A lifting eye is molded on the connector end for removal with hot sticks.

### SU SYSTEM CONNECTORS

SU-ES System connectors are made from orange SALCOR® Type II and meet ASTM D1049 specifications. RIB-GRIP® construction is used to ensure a strong lock to the straight lengths of SU System Line Hose and covers. The UC2-ES is used to connect Extended Lip Hose to PTHL and LRG Insulator Covers, OR 134-ES Dead End Protectors, and 2 in (51 mm) and 2.5 in (64 mm) SU System and Conventional Line Hose.

#### STRAIGHT LINE HOSE, TYPE II

Item #	Class	Dimensions I.D. x Length in x ft (mm)	Weight Each lb (kg)
OP58-6-ES	1		
SU150-3-ES*	4	1.5 in x 3 in (38 mm x 915 mm)	6 lb (2.7 kg)
SU150-45-ES*	4	1.5 in x 4.5 in (38 mm x 1372 mm)	8.5 lb (3.8 kg)
SU150-6-ES*	4	1.5 in x 6 in (38 mm x 1820 mm)	12 lb (5.4 kg)
SU250-45-ES	4	2.5 in x 4.5 in (64 mm x 1372 mm)	11 lb (5 kg)
ESU150-6C-ES	4	1.5 in x 6 in (38 mm x 1820 mm)	

#### CONNECTOR END LINE HOSE, TYPE II

SU150-3C-ES*	4	1.5 in x 3 in (38 mm x 915 mm)	7 lb (3.2 kg)
SU150-45C-ES*	4	1.5 in x 4.5 in (38 mm x 1372 mm)	9 lb (4.1 kg)
SU150-6C-ES*	4	1.5 in x 6 in (38 mm x 1820 mm)	12 lb (5.4 kg)

#### SU SYSTEM CONNECTOR, TYPE II

Item #	Class	Length x Height in (mm)	Use with Line Hose I.D. in (mm)	Weight Each lb (kg)
UC2-ES	4	10.5 in x 6 in (263 mm x 150 mm)	1.5 in (40 mm)	2 lb (0.9 kg)
UC-ES	4	10.5 in x 7.75 in (263 mm x 193 mm)	2 in and 2.5 in (51 mm and 64 mm)	3 lb (1.4 kg)

\* Molded one piece design.

### SU150-ES SERIES MOLDED DESIGN

#### Advantages

- Consistent overall profile
- Offers greater electrical insulation between the connector and line hose
- Serrations are also molded creating an improved locking system
- Complies with current ASTM D1050 specifications



SU150-45-ES



SU150-3C-ES

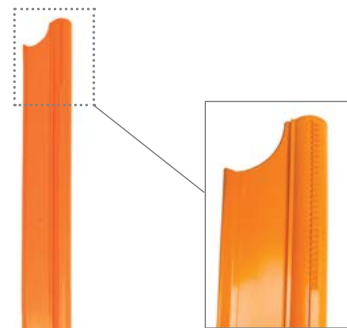

SU150-6C-ES



UC-ES

## DEAD END PROTECTORS EXTENDED LIP SU SYSTEM

### ELECTRICAL PROTECTION FOR CLASS 3 AND CLASS 4 SPECIFICATIONS

Dead End Protectors quickly cover dead end bells or polymer insulators providing complete electrical protection for Class 3 and Class 4 applications. The protectors are easily installed and removed from an insulated platform or aerial device with rubber gloves or SU System Applicators.



**i** RIB-GRIP® construction creates a dependable interlock

All dead end protector styles have RIB-GRIP® construction to interlock with 1.5 in (38 mm) I.D. line hose. OR134-ES, Class 4, accepts Straight Line Hose. The outer ribs interlock with 2 in (51 mm) and 2.5 (64 mm) in I.D. line hose when the UC2-ES SU System Connector is used.

All Protectors comply with current ASTM D1049 specifications..

#### DEAD END PROTECTOR, TYPE II

Item #	Description	ASTM Class	Dimensions: in (mm)			Color	Weight Each lb (kg)
			Fits Bell Size in (mm)	I.D. Body in (mm)	Overall Length in (mm)		
OR134-ES	Protector	4	3 in to 4.25 in (76 mm to 108 mm)	4.76 in (121 mm)	37 in (940 mm)	Orange	13 lb (6 kg)
OR134E-ES	Protector with Shot Gun Eye Assembly (2323-ES)	4	3 in to 4.25 in (76 mm to 108 mm)	4.76 in (121 mm)	37 in (940 mm)	Orange	13 lb (6 kg)
U106E-ES	Protector with Shot Gun Eye Assembly (2340-ES)	3	2 in to 6 in (51 mm to 152 mm)	7 in (178 mm)	28.5 in (724 mm)	Black	9 lb (4.1 kg)

#### SHOT GUN EYE ASSEMBLY

Item #	Description	Hot Stick Style	Weight Each lb (kg)
2323-ES	Shot Gun Eye Assembly for SU Hose	Shot Gun	13 lb (6 kg)
2359-ES	Eye Assembly for SU System Insulator Covers	Shot Gun	13 lb (6 kg)

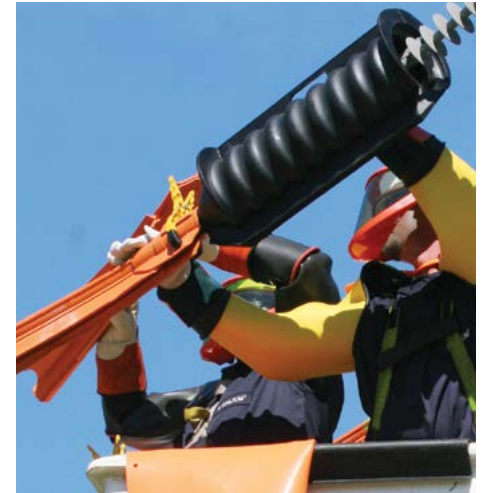

OR134-ES



2323-ES



2359-ES



## INSULATOR COVERS EXTENDED LIP SU SYSTEM

All covers are made from orange SALCOR® and feature RIB-GRIP® Construction. They can be installed with a hot stick or rubber gloves. All covers comply with ASTM D1049 specifications.

### PIN-TYPE COVER

The UH-ES Pin-Type Cover covers insulators up to ANSI standard C29.5 Class 5. The sides are cut to be used on small insulators without resting on the cross arm. When covering a 7 in (178 mm) diameter insulator on a double arm construction, the ends of the cover will meet flush on 10.5 in (267 mm) pin centers.

The LRG-ES SU-ES System Pin-Type Cover fits insulators 10.5 in (267 mm) in diameter and is used with 2.5 in (64 mm) Class 4 Extended Lip SU-SE System Line Hose. Always use clamp pins to secure the device into position. Pinning rings have been placed on the cover's arms to prevent separation.

### POST-TYPE COVER

Post-Type Insulator Covers interlock with 1.5 in (38 mm) Class 4 Extended Lip SU-ES System or Conventional Line Hose. The PTHS-ES for insulators up to 12 in (305 mm) and the PTHL-ES for insulators up to 16 in (406 mm) in height. The PTHL-ES cover also has external ribs on the ears which secures 2.5 in (64 mm) I.D. line hose. Always use clamp pins to secure the device into position.

### UNIVERSAL COVER

The Class 4 MRG-ES Universal Cover covers pin-type insulators through 8.5 in (216 mm) diameter and 13.8 kV post-type insulators. A trim bead permits use on both 35 kV and 15 kV cross arm construction.

### STIRRUP COVER

The USC-ES Stirrup Cover is a lightweight cover that can be installed using rubber gloves or a hot stick. The USC-ES also feature RIB-GRIP® construction and is meant to be used with Extended Lip SU Systems or Conventional Line Hose.



## INSULATOR COVERS EXTENDED LIP SU SYSTEM

PIN-TYPE INSULATOR COVER, TYPE II								
Item #	Description	ASTM Class	Use With Insulator Class	Dimensions: in (mm)				Weight Each: lb (kg)
				Fits Line Hose	Insulator Max. Diameter	I.D. Body	Height	
LRG-ES	Insulator Cover	4	55-6	2.5 in (63 mm)	10.5 in (263 mm)	12 in (305 mm)	16 in (400 mm)	8 lb (3.6 kg)
MRG-ES	Insulator Cover	4	Pin-Type 55-5, Type 13.2 kV F Neck, Type 13.2 kV C Neck	1.5 in (40 mm), 2.5 in (63 mm)	8.5 in (213 mm)	9 in (221 mm)	12.25 in (306 mm)	7 lb (3.2 kg)
MRGE-ES	Insulator Cover with Shot Gun Eye Assembly (2359-ES)	4	Pin-Type 55-5, Type 13.2 kV F Neck, Type 13.2 kV C Neck	1.5 in (40 mm), 2.5 in (63 mm)	8.5 in (213 mm)	9 in (221 mm)	12.25 in (306 mm)	7 lb (3.2 kg)
UH-ES	Insulator Cover	3	55-1, 2, 3, 4, 5	1.5 in (40 mm)	7 in (175 mm)	7.5 in (184 mm)	12 in (300 mm)	6 lb (4.4 kg)
POST-TYPE INSULATOR COVER, TYPE II								
PTHL-ES	Insulator Cover	4	57-2	1.5 in (40 mm), 2.5 in (63 mm)	6.5 in (163 mm)	7 in (172 mm)	16 in (400 mm)	8 lb (3.6 kg)
PTHS-ES	Insulator Cover	4	57-2	1.5 in (40 mm)	7 in (175 mm)	7.5 in (184 mm)	12 in (300 mm)	4 lb (1.8 kg)
STIRRUP COVER, TYPE II								
USC-ES	Stirrup Cover	4	—	1.5 in (40 mm)	—	14 in (263 mm)	15.5 in (388 mm)	5 lb (2.3 kg)



## CABLE END CAPS & ARRESTER COVERS

Cable End Caps are applied with rubber gloves. They are used on high voltage distribution cable ends found in vaults, cubicles and substations when cable remains energized during work. Cable End Caps are made from Type II orange SALCOR®.

### CABLE END CAPS

For versatile applications, use the Looped Cable End Cap. It is an improved version of our Self-Securing Cable End Cap. The looped end feature not only allows the product to be applied with appropriate rubber insulating gloves like our standard cable end caps but also enables the product to be applied using a hotstick.

For Underground Distribution, the Self-Securing Cable End Caps are rated at 20 kV and have a minimum wall thickness of 0.25 in (6.35 mm). They keep moisture and contamination off trimmed cable end, and the self-securing slot keeps the cable locked safely inside the end cap. These Cable End Caps are applied with rubber gloves.

### LIGHTNING ARRESTER COVERS

Lightning Arrester Covers are made from Type II orange SALCOR®. The slot allows the cap to fit directly over the energized lightning arrester and the line connection. Lightning Arrester Covers can be applied with rubber gloves or a hotstick.

Clear Cable Covers are made from clear PVC round or oval tube. Each cover has a grip-all handle attachment for installation with an insulated grip-all hotstick.

Clear PVC Stress Cone Cover has a grip-all attachment that allows this cover to be installed with an insulated grip all hotstick. The inspection window can be opened for testing with a voltage sensor.

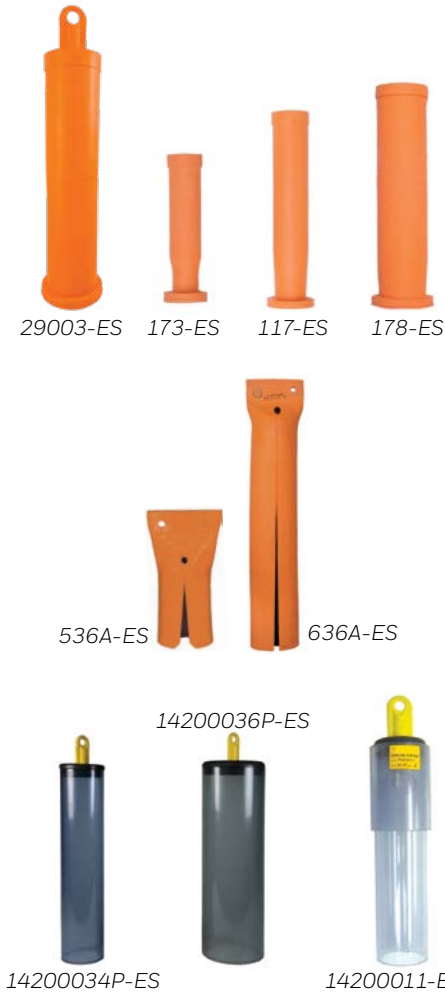

SELF-SECURING CABLE END CAP, TYPE II					
Item #	ASTM Class	Description	I.D. × Length: in (mm)	Cable Size	Weight: lb (kg)
29003-ES	2	Looped Cable End Cap	3.19 in × 9.13 in (81 mm × 486 mm)	—	2.27 lb (1kg)
117-ES	2	SALCOR® Cap Cable End Cap, Orange	1.38 in × 10 in (35 mm × 254 mm)	#4/0 to 500 MCM	0.5 lb (0.23 kg)
173-ES	2	SALCOR® Cap Cable End Cap, Orange, 6	0.81 in × 6 in (21 mm × 152 mm)	#4 to #4/0 AWG	0.25 lb (0.1 kg)
177-ES	2	SALCOR® Cap Cable End Cap, Orange, 10	2.25 in × 12 in (57 mm × 305 mm)	350 to 750 MCM	0.75 lb (0.35 kg)
178-ES	2	SALCOR® Cap Cable End Cap, Orange, 12	3.19 in × 16 in (81 mm × 406 mm)	800 to 1000 MCM	1.5 lb (0.7 kg)

BELL STUD COVER, TYPE II					
21236-ES		Bell Stud Cover, Orange			

LIGHTNING ARRESTER COVER, TYPE II					
536A-ES	4	Lightning Arrester Cover, Orange	4.5 in × 15 in (113 mm × 375 mm)	—	3 lb (1.4 kg)
536-ES	4	SALCOR® Cap Cable End Cap			
636A-ES	4	Lightning Arrester Cover, Orange	5.5 in × 22 in (138 mm × 550 mm)	—	5 lb (2.3 kg)
636-ES	4	Cable End Cap, Orange			

CLEAR CABLE COVER						
Item #	ASTM Class	Rating	Dimensions			Weight: lb (kg)
			Length: in (mm)	I.D.: in (mm)	O.D.: in (mm)	
14200032P-ES	2	14.6 kV	20 in (508 mm)	2 in (51 mm)	2.38 in (60 mm)	1.5 lb (0.68 kg)
14200033P-ES	2	14.6 kV	20 in (508 mm)	3 in (76 mm)	3.38 in (86 mm)	3.2 lb (1.45 kg)
14200034P-ES	2	14.6 kV	20 in (508 mm)	4 in (102 mm)	4.38 in (111 mm)	4.3 lb (1.95 kg)
14200036P-ES	2	14.6 kV	20 in (508 mm)	6 in (152 mm)	6.5 in (165 mm)	5.3 lb (2.41 kg)

## SPECIAL EQUIPMENT

### TAGGING DEVICE

Made from molded orange SALCOR®, the TD-ES Tagging Device is used to tag opened disconnect switches. It allows "Hold" cards to be placed on the circuit and fits over the heads of 1.25 in (32 mm) and 1.5 in (38 mm) switch sticks.

### METER TERMINAL COVER

The TH111-ES Meter Terminal Cover, made of orange SALCOR®, is used to avoid accidental contact with energized parts on 100 and 200 Amp single phase meter sockets.

ACCESSORIES AND SPECIAL EQUIPMENT			
Item #	Description	Dimensions in (mm)	Weight: lb (kg)
TD-ES	Tagging Device	7.25 in (184 mm) Long Slot: 2.13 in × 0.63 in (54 mm × 16 mm) Cup: 2.5 in × 1.75 in (64 mm × 44 mm)	0.25 lb (0.1 kg)
TH111-ES	Meter Terminal Cover	3 in × 3.5 in × 1.5 in (76 mm × 89 mm × 38 mm)	1.6 lb (41 kg)

### SPADE COVER

Spade Covers are easily installed to provide temporary insulation when working in padmount transformers and other electrical apparatus. If spade covers are securely held in place, they may be left on spades or connectors indefinitely for front-end protection. The larger SC5-ES, SC6-ES, or SC6G-ES are also used to cover primary elbows. In addition, they also cover the larger and longer multiple lead primary and secondary fittings and lugs that are used in underground enclosures and vaults.

Molded from flexible SALCOR®, Spade Covers have excellent aging and weathering characteristics. The opening at the top end of the slot holds the cover onto the terminal. Wide lips extending along the slot provide additional protection over the connection.

Type II Spade Covers are for Class 2 applications and comply with current ASTM D1049 specifications.

SPADE COVER				
Item #	Description	Dimensions in (mm)	Lip Extension: in (mm)	Weight: lb (kg)
SC4-ES	Spade Cover with Lip Extension	2.75 in × 4.4 in × 10.75 in (70 mm × 112 mm × 273 mm)	1 in (25 mm)	.25 lb (0.1 kg)
SC5-ES	Spade Cover with Lip Extension	3 in × 6 in × 10 in (76 mm × 152 mm × 254 mm)	2 in (51 mm)	2 lb (0.9 kg)
SC6-ES	Spade Cover with Lip Extension	3 in × 6 in × 10 in (76 mm × 152 mm × 254 mm)	1.25 in (32 mm)	1.4 lb (0.6 kg)
SC6G-ES	Spade Cover with Lip Extension	3 in × 6 in × 10 in (76 mm × 152 mm × 254 mm)	1.25 in (32 mm)	1.4 lb (0.6 kg)



The Tagging Device fits over the head of switch sticks to tag opened disconnect switches.



TH111-ES



TH111-ES



SC6G-ES



## INSULATING BLANKETS EYELET STYLE

### HIGH QUALITY

Salisbury's Type II SALCOR® blankets are of the highest quality available today. They hold their color and flexibility and maintain physical properties and dielectric strength, required by ASTM standard, in the field longer than any other blanket on the market.

### OZONE RESISTANT

The Orange SALCOR® is manufactured from a well researched blend of prime EPDM, which is naturally resistant to ozone. This blend of Prime EPDM offers superb flexibility: similar to that of a Type I natural rubber blanket. This ensures the Salisbury Type II SALCOR® blanket will pass the ASTM D 1048 Ozone Tests.

### EYELET STYLE INSULATING BLANKETS

These blankets were designed to be easily secured in place by using blanket pins, snap buttons or ty-straps. Eyelet blankets are flexible and feature a reinforced beaded edge and eyelets for added strength and tear-resistance.

### IEC 61112 COMPLIANT



400E-ES (27 x 36 in)



300E-ES (36 x 36 in)



900E-ES (36 x 36 in)

# INSULATING BLANKETS

## General Care & Inspection of Salisbury Rubber Goods

Type I natural (non-ozone resistant) and Type II SALCOR® synthetic rubber (resistant to ozone) both provide electrical workers with the highest level of electrical insulating protection. However, in order to maintain this level of protection and ensure long life, it is essential that rubber goods are properly cared for. Before each use, rubber goods should be visually inspected for holes, embedded wires, rips or tears, ozone cutting, UV checking and signs of chemical deterioration. For additional information, refer to ASTM F1236, standard guide for visual inspection of electrical protective rubber products.

### FAQ

**Q: How often do I need to test blankets?**

**A:** Blankets issued for service need to be tested once a year. See ASTM D479 8.1 for testing requirements.

### SALISBURY EXCLUSIVE

Only Salisbury formulates compounds, mixes, molds and tests blankets in our own ISO 9000:2008 registered facilities.

## INSULATING BLANKETS EYELET STYLE

INSULATING BLANKET - EYELET STYLE SPECIFICATIONS							
Item #	Description	Eyelets	Class	Type	Color	Size in (cm)	Weight ea lb (kg)
12-ES	Eyelet style blanket	28	Class 2	II	Black	22 x 22 in (55.9 x 55.9 cm)	3 lb (1.4 kg)
12-1-ES	Eyelet style blanket	28	Class 2	I	Black	22 x 22 in (55.9 x 55.9 cm)	3 lb (1.4 kg)
12B-ES	Eyelet style blanket w/buttons	28	Class 2	II	Black	22 x 22 in (55.9 x 55.9 cm)	3.8 lb (1.7 kg)
13-10-2-ES	Eyelet style blanket	10	Class 2	II	Orange	22 x 22 in (55.9 x 55.9 cm)	3 lb (1.4 kg)
13-2-ES	Eyelet style blanket	28	Class 2	II	Orange	22 x 22 in (55.9 x 55.9 cm)	3.6 lb (1.6 kg)
400E-ES	Eyelet style blanket	6	Class 2	II	Black	27 x 36 in (68.6 x 91.4 cm)	6 lb (2.3 kg)
700E-ES	Eyelet style blanket	6	Class 2	II	Maroon	36 x 36 in (91.4 x 91.4 cm)	7.3 lb (3.3 kg)
900E-2-ES	Eyelet style blanket	6	Class 2	II	Orange	36 x 36 in (91.4 x 91.4 cm)	7.8 lb (3.5 kg)
901E-2-ES	Eyelet style blanket	6	Class 2	II	Black	36 x 36 in (91.4 x 91.4 cm)	8.5 lb (3.9 kg)
1500-ES	Eyelet style blanket	28	Class 2	II	Black	36 x 36 in (91.4 x 91.4 cm)	8 lb (3.6 kg)
1700-ES	Eyelet style blanket	28	Class 2	II	Orange	36 x 36 in (91.4 x 91.4 cm)	8 lb (3.6 kg)
300E-ES	Eyelet style blanket	6	Class 2	I	Black	36 x 36 in (91.4 x 91.4 cm)	8 lb (3.6 kg)
300E-DS-ES	Eyelet style blanket w/date stamp	6	Class 2	I	Black	36 x 36 in (91.4 x 91.4 cm)	8 lb (3.6 kg)
902E-ES	Eyelet style blanket	6	Class 2	II	Black	36 x 36 in (91.4 x 91.4 cm)	8 lb (3.6 kg)
903E-ES	Eyelet style blanket	6	Class 3	II	Orange	36 x 36 in (91.4 x 91.4 cm)	8.6 lb (3.9 kg)
13-10-ES	Eyelet style blanket	10	Class 4	II	Orange	22 x 22 in (55.9 x 55.9 cm)	3 lb (1.4 kg)
13-1-ES	Eyelet style blanket	28	Class 4	II	Black	22 x 22 in (55.9 x 55.9 cm)	3.6 lb (1.6 kg)
13-ES	Eyelet style blanket	28	Class 4	II	Orange	22 x 22 in (55.9 x 55.9 cm)	3.6 lb (1.6 kg)
13T-ES	Eyelet style blanket w/transponder	28	Class 4	II	Orange	22 x 22 in (55.9 x 55.9 cm)	3.6 lb (1.6 kg)
1000E-ES	Eyelet style blanket	6	Class 4	II	Orange	27 x 36 in (68.6 x 91.4 cm)	6 lb (2.3 kg)
1000EV-ES	Eyelet style blanket w/Velcro®	6	Class 4	II	Orange	27 x 36 in (68.6 x 91.4 cm)	8.1 lb (3.7 kg)
1000EV-WV-ES	Eyelet style blanket w/wide Velcro®	6	Class 4	II	Orange	27 x 36 in (68.6 x 91.4 cm)	6.3 lb (2.9 kg)
1001E-ES	Eyelet style blanket	6	Class 4	II	Black	27 x 36 in (68.6 x 91.4 cm)	6 lb (2.3 kg)
1002E-ES	Eyelet style blanket	6	Class 4	II	Orange	27 x 36 in (68.6 x 91.4 cm)	6.3 lb (2.9 kg)
900E12-ES	Eyelet style blanket	12	Class 4	II	Orange	36 x 36 in (91.4 x 91.4 cm)	8.6 lb (3.9 kg)
900E-DS-ES	Eyelet style blanket w/date stamp	6	Class 4	II	Orange	36 x 36 in (91.4 x 91.4 cm)	8.6 lb (3.9 kg)
900-ES	Eyelet style blanket	6	Class 4	II	Orange	36 x 36 in (91.4 x 91.4 cm)	8.6 lb (3.9 kg)
900ET-ES	Eyelet style blanket w/transponder	6	Class 4	II	Orange	36 x 36 in (91.4 x 91.4 cm)	8.6 lb (3.9 kg)
900EV-ES	Eyelet style blanket w/Velcro®	6	Class 4	II	Orange	36 x 36 in (91.4 x 91.4 cm)	8.6 lb (3.9 kg)
900EVT-ES	Eyelet style blanket w/Velcro® & transponder	6	Class 4	II	Orange	36 x 36 in (91.4 x 91.4 cm)	8.6 lb (3.9 kg)
901E-ES	Eyelet style blanket	6	Class 4	II	Black	36 x 36 in (91.4 x 91.4 cm)	8 lb (3.6 kg)

Note: All blankets comply with current ASTM D1048 specifications.

\*Type I IEC Compliant blankets



900EV-ES Eyelet style blanket with Velcro®

## INSULATING BLANKETS SLOTTED STYLE

INSULATING BLANKET - EYELET STYLE SLOTTED SPECIFICATIONS							
Item #	Description	Eyelets	Class	Type	Color	Size in (cm)	Weight ea kg (lb)
14-ES	Slotted eyelet style blanket	28	Class 2	II	Black	22 x 22 in (55.9 x 55.9 cm)	1.4 kg (3 lb)
14-1-ES	Slotted eyelet style blanket	28	Class 2	I	Black	22 x 22 in (55.9 x 55.9 cm)	1.4 kg (3 lb)
15-2-ES	Slotted eyelet style blanket	28	Class 2	II	Orange	22 x 22 in (55.9 x 55.9 cm)	1.4 kg (3 lb)
1100-ES	Slotted eyelet style blanket	28	Class 2	II	Black	36 x 36 in (91.4 x 91.4 cm)	3.2 kg (7 lb)
1100-1-ES	Slotted eyelet style blanket	28	Class 2	I	Black	36 x 36 in (91.4 x 91.4 cm)	3.2 kg (7 lb)
1100-DS-ES	Slotted eyelet style blanket w/date stamp	28	Class 2	II	Black	36 x 36 in (91.4 x 91.4 cm)	3.2 kg (7 lb)
1200-ES	Slotted eyelet style blanket	28	Class 2	II	Maroon	36 x 36 in (91.4 x 91.4 cm)	3.2 kg (7 lb)
1300-3-ES	Slotted eyelet style blanket	28	Class 3	II	Orange	36 x 36 in (91.4 x 91.4 cm)	3.2 kg (7 lb)
15-ES	Slotted eyelet style blanket	28	Class 4	II	Orange	22 x 22 in (55.9 x 55.9 cm)	1.4 kg (3 lb)
15-1-ES	Slotted eyelet style blanket	28	Class 4	II	Black	22 x 22 in (55.9 x 55.9 cm)	1.4 kg (3 lb)
15B-ES	Slotted eyelet style blanket w/buttons	28	Class 4	II	Orange	22 x 22 in (55.9 x 55.9 cm)	1.7 kg (3.8 lb)
1300-ES	Slotted eyelet style blanket	28	Class 4	II	Orange	36 x 36 in (91.4 x 91.4 cm)	3.2 kg (7 lb)
1300B-ES	Slotted eyelet style blanket w/buttons	28	Class 4	II	Orange	36 x 36 in (91.4 x 91.4 cm)	3.5 kg (7.8 lb)
1300-DS-ES	Slotted eyelet style blanket w/date stamp	28	Class 4	II	Orange	36 x 36 in (91.4 x 91.4 cm)	3.2 kg (7 lb)
1300T-ES	Slotted eyelet style blanket w/transponder	28	Class 4	II	Orange	36 x 36 in (91.4 x 91.4 cm)	3.2 kg (7 lb)
1300V-ES	Slotted eyelet style blanket w/Velcro®	28	Class 4	II	Orange	36 x 36 in (91.4 x 91.4 cm)	3.2 kg (7 lb)
1301-ES	Slotted eyelet style blanket	28	Class 4	II	Black	36 x 36 in (91.4 x 91.4 cm)	3.2 kg (7 lb)
1301-2-ES	Slotted eyelet style blanket	28	Class 2	II	Black	36 x 36 in (91.4 x 91.4 cm)	3.2 kg (7 lb)
1301-DS-ES	Slotted eyelet style blanket w/date stamp	28	Class 4	II	Black	36 x 36 in (91.4 x 91.4 cm)	3.2 kg (7 lb)
1302-ES	Slotted eyelet style blanket	18	Class 4	II	Orange	36 x 36 in (91.4 x 91.4 cm)	3.2 kg (7 lb)
1302-DS-ES	Slotted eyelet style blanket w/date stamp	18	Class 4	II	Orange	36 x 36 in (91.4 x 91.4 cm)	3.2 kg (7 lb)
1304-ES	Slotted eyelet style blanket	18	Class 4	II	Orange	36 x 36 in (91.4 x 91.4 cm)	3.2 kg (7 lb)
1304-DS-ES	Slotted eyelet style blanket	18	Class 4	II	Orange	36 x 36 in (91.4 x 91.4 cm)	3.2 kg (7 lb)

INSULATING BLANKET SPECIFICATIONS							
Item #	Description	Eyelets	Class	Type	Color	Size cm (in)	Weight ea kg (lb)
300-ES	Insulating blanket	-	Class 2	I	Black	91.4 x 91.4 cm (36 x 36 in)	3.6 kg (8 lb)

## LOW-VOLT BLANKETS AND ACCESSORIES

### LOW VOLTAGE INSULATING BLANKETS

Low Voltage Insulating Blankets are made of Type II SALCOR® rubber. Insulating blankets are available with or without hook and pile (Zip or Plain style), as noted in the chart below.

YELLOW LOW VOLTAGE INSULATING BLANKETS							
Item #	Description	Eyelets	Class	Type	Color	Size in (cm)	Weight ea lb (kg)
1212LV-ES	Insulating blanket w/velcro	-	Class 0	II	Maroon	12 in x 12 in (30.5 cm x 30.5 cm)	1 lb (0.5 kg)
1212LVNV-ES	Insulating blanket	-	Class 0	II	Maroon	12 in x 12 in (30.5 cm x 30.5 cm)	1 lb (0.5 kg)
1212YLV-ES	Insulating blanket w/velcro	-	Class 0	II	Yellow	12 in x 12 in (30.5 cm x 30.5 cm)	1 lb (0.5 kg)
1212YLVNV-ES	Insulating blanket	-	Class 0	II	Yellow	12 in x 12 in (30.5 cm x 30.5 cm)	1 lb (0.5 kg)
1218RL-ES	Insulating blanket w/velcro	-	Class 0	II	Maroon	12 in x 18 in (30.5 cm x 45.7 cm)	-
1218RLNV-ES	Insulating blanket	-	Class 0	II	Maroon	12 in x 18 in (30.5 cm x 45.7 cm)	-
1236YLV-ES	Insulating blanket w/velcro	-	Class 0	II	Yellow	12 in x 36 in (30.5 cm x 91.4 cm)	1.5 lb (0.7 kg)
1236YLVNV-ES	Insulating blanket	-	Class 0	II	Yellow	12 in x 36 in (30.5 cm x 91.4 cm)	1.5 lb (0.7 kg)
123LV-ES	Insulating blanket w/velcro	-	Class 0	II	Maroon	12 in x 36 in (30.5 cm x 91.4 cm)	-
123LVNV-ES	Insulating blanket	-	Class 0	II	Maroon	12 in x 36 in (30.5 cm x 91.4 cm)	-
1818MLV-ES	Insulating blanket w/velcro	-	Class 0	II	Maroon	18 in x 18 in (45.7 cm x 45.7 cm)	-
1818YLV-ES	Insulating blanket w/velcro	-	Class 0	II	Yellow	18 in x 18 in (45.7 cm x 45.7 cm)	-
1818YLV-DS-ES	Insulating blanket w/velcro & date stamp	-	Class 0	II	Yellow	18 in x 18 in (45.7 cm x 45.7 cm)	-
1818YLVNV-ES	Insulating blanket	-	Class 0	II	Yellow	18 in x 18 in (45.7 cm x 45.7 cm)	-
1818YLVNV-DS-ES	Insulating blanket w/date stamp	-	Class 0	II	Yellow	18 in x 18 in (45.7 cm x 45.7 cm)	-
1836YLV-ES	Insulating blanket w/velcro	-	Class 0	II	Yellow	18 in x 36 in (45.7 cm x 91.4 cm)	-
1836YLVNV-ES	Insulating blanket	-	Class 0	II	Yellow	18 in x 36 in (45.7 cm x 91.4 cm)	-
183LV-ES	Insulating blanket	-	Class 0	II	Maroon	18 in x 36 in (45.7 cm x 91.4 cm)	-
183LVNV-ES	Insulating blanket	-	Class 0	II	Maroon	18 in x 36 in (45.7 cm x 91.4 cm)	-
183OS-ES	Insulating blanket w/velcro	-	Class 4	II	Orange	18 in x 36 in (45.7 cm x 91.4 cm)	4.6 lb (2.1 kg)
183OS-WV-ES	Insulating blanket w/wide velcro	-	Class 4	II	Orange	18 in x 36 in (45.7 cm x 91.4 cm)	4.6 lb (2.1 kg)
186-ES	Insulating blanket	-	Class 4	II	Orange	18 in x 16 in (45.7 cm x 40.6 cm)	-
3636LV-ES	Insulating blanket w/velcro	-	Class 0	II	Maroon	36 in x 36 in (91.4 cm x 91.4 cm)	-
3636LVNV-ES	Insulating blanket	-	Class 0	II	Maroon	36 in x 36 in (91.4 cm x 91.4 cm)	-
3636YLV-ES	Insulating blanket w/velcro	-	Class 0	II	Yellow	36 in x 36 in (91.4 cm x 91.4 cm)	-
3636YLVNV-ES	Insulating blanket	-	Class 0	II	Yellow	36 in x 36 in (91.4 cm x 91.4 cm)	-



1212YLV-ES



1212YLVNV-ES



1212YLV-ES Back side

NOTE: Other sizes are available, contact your local Salisbury representative for availability.

## SWITCHBOARD MATTING

### SWITCHBOARD MATTING

Switchboard matting is placed permanently in front of switchgear, motor control centers and other high voltage apparatus to provide an additional level of protection for electrical workers. Switchboard matting is made from 1/4 in (6.4 mm) thick and tested to 20kV to comply with ASTM D178, Class 2 specifications. The corrugated surface acts as a safety tread while reducing the possibility of metal particles becoming embedded. Class 2, switchboard matting is made in 25 yard rolls which can be custom cut to specified lengths as per customer request. Class 4 is sold in full 60 ft rolls only.

Class 2 Maximum Use Voltage: 17,000 VAC  
Class 4 Maximum Use Voltage: 36,000 VAC



M36-2-ES



Matting Cross-Section

Item #	Dimensions in (mm)	Weight lb (kg)
M24-2-ES	0.25 in x 24 in (6 mm x 610 mm)	9 lb (4.1 kg)
M30-2-ES	0.25 in x 30 in (6 mm x 762 mm)	12 lb (5.4 kg)
M36-2-ES	0.25 in x 36 in (6 mm x 914 mm)	15 lb (6.8 kg)
M48-2-ES	0.25 in x 48 in (6 mm x 1219 mm)	18 lb (8.2 kg)
M36-4-ES*	0.5 in x 36 in x 60 in (12 mm x 914 mm x 18,3 mm)	684 lb (307.8 kg)

All switchboard matting complies with current ASTM D178 standards.

\*Sold in full rolls only.



## ROLL BLANKETS

### SHOCK PROTECTION

#### ROLL BLANKETS

Salisbury roll blankets allow workers to custom-cut blankets to fit each application at the job site. This minimizes the number of different low voltage blanket sizes and shapes that would otherwise need to be carried from job to job. Clear PVC material permits complete visibility yet provides the necessary insulating properties meeting ASTM F1742 standards.

All classes of roll blankets are easy to cut and flexible to -40°F. Highly puncture and tear resistant, each class of blanket is also flame, oil and ozone resistant.

#### CLEAR PVC ROLL BLANKETS

Salisbury's roll blanket line includes a Class I clear PVC material that permits complete visibility, yet provides the necessary insulating properties meeting ASTM F1742 standards.

ROLL BLANKETS					
Item #	Description	Class	Type	Color	Dimensions in (ft)
RLBPVCO-48-ES	Roll blanket	Class 0	M	PVC	48 in x 600 in (50 ft)
RLBPVC1-ES	Roll blanket	Class 1	M	PVC	36 in x 360 in (30 ft)
RLBPVC1-48-ES	Roll blanket	Class 1	M	PVC	48 in x 600 in (50 ft)
RLBPVC1-SRP-ES	Roll blanket	Class 1	M	PVC	36 in x 360 in (30 ft)
SL104025-ES	Roll blanket	Class 1	M	PVC	48 in x 300 in (25 ft)

NOTE: Other sizes are available, contact your local Salisbury representative for availability.



RLBPVC1

## BLANKET ACCESSORIES CLAMP PINS

In addition to other uses in the utility industry, Blanket Clamp Pins can be effectively used to hold insulating blankets and rubber cover-ups in place. Springs are used for tension while extra holes in the body of the pin are used to grip conductors and prevent line hoses from sliding.

The 21 pin has been designed to open to a full 5.5 inches, the widest of any standard plastic pin in the market. To accommodate application using a hot stick, the ends of the pin have been tapered to fit into the end of any clampstick. This allows the same 21 pin to be installed in line with the stick.

Blanket pins are made of fiberglass reinforced nylon or silver-free hardwoods. Most pins have molded rubber tips to increase slip resistance.

CLAMP PINS				
Item #	Description	Length in (mm)	Jaw Opening in (mm)	Weight ea lb (kg)
20-ES	Wood w/pin boots	8.5 in (216 mm)	4.75 in (121 mm)	0.33 lb (0.15 kg)
25-ES	Wood w/o pin boots	7 in (178 mm)	1.6 in (41 mm)	0.25 lb (0.11 kg)
26-ES	Wood w/pin boots	10 in (254 mm)	7 in (178 mm)	0.5 lb (0.23 kg)
21-ES	Nylon w/pin boots	8.5 in (216 mm)	4.75 in (121 mm)	0.33 lb (0.15 kg)
HS21-ES	Nylon w/ pin boots	10 in (254 mm)	7 in (178 mm)	0.5 lb (0.23 kg)



20



25-ES



26-ES



Clamp Pins help line hose from slipping



HS21-ES



Salisbury 21-ES Blanket Pin

## BLANKET ACCESSORIES FASTENERS

### BLANKET BUTTONS

Blanket Buttons are designed to secure eyelet-style insulating blankets. The B1-ES button, made of orange plastic, snaps through the eyelet with thumb pressure on the large head. The bright orange polystyrene B23-ES two-way buttons are inserted into the eyelets for use with a shotgun clamp stick or standard-duty switch stick.

### MAGNETIC BLANKET BUTTONS

Magnetic Blanket Buttons are designed for use in eyelets of insulating blankets when covering energized portions in hard-to-cover areas like pad mounts, cubicles, switchboards and substations. Four permanent floating magnets are mounted between nickel-plated steel plates. May be applied manually, wearing rubber gloves, or with a shotgun stick.

BLANKET BUTTONS		
Item #	Description	Weight ea oz (kg)
B1-ES	Snap-button, Orange	1 oz (0.03 kg)
B23-ES	Two-way button, Orange	1 oz (0.03 kg)
MB6-ES	Magnetic blanket button	7 oz (0.2 kg)

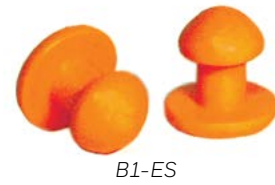

B1-ES

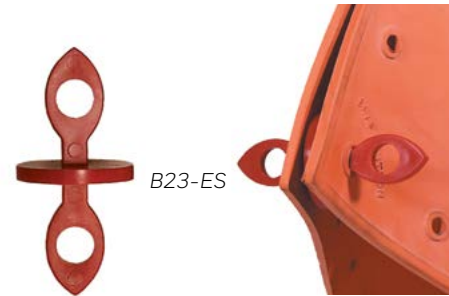

B23-ES



MB6-ES

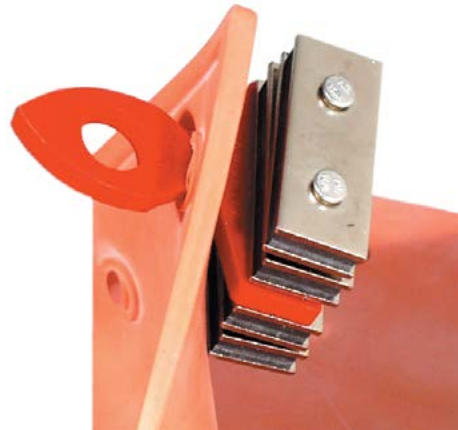

## BLANKET ACCESSORIES STORAGE

### P4H BLANKET CANISTER

Salisbury's P4H-ES blanket canister revolutionizes the way you'll store your blankets. The P4H-ES canister has a sturdier construction than the regular P4-ES, with integrated feet to keep the canister from rolling while being transported by truck or stored at the workplace. The ergonomic handle runs the entire length of the canister, making lifting and carrying up to four 36 in x 36 in blankets much easier. Slots are provided within the canister to allow it to be secured in buckets or on trucks.

### BLANKET ROLL UPS

Blanket Roll Ups provide a safe and convenient means for protecting blankets from damage while in transport or storage. Ruggedly constructed of 18 oz. vinyl with side flaps to confine the blankets into position and prevent damage to the edges. Two heavy 33 in (0.84 m) web straps with buckles close the roll-up, and includes a web carrying handle.

### STORAGE TIPS

When more than one blanket is stored, the most convenient method of loading is to roll and insert each blanket into the canister independently. A single blanket can then be removed without removing the others. For maximum useful life, never fold, crease or compress insulating blankets while in storage.



P2-ES

P4-ES

P6-ES

CANISTERS					
Item #	Description	Fits Blanket Max Size in (mm)	Dimensions in (mm)	Capacity	Weight ea lb (kg)
22-ES	Roll-up vinyl	22 in (559 mm)	56 in x 42 in (1651 mm x 1067 mm)	1-4 blankets	1.5 lb (0.68 kg)
36-ES	Roll-up vinyl	46 in (1168 mm)	67 in x 55 in (1702 mm x 1397 mm)	1-4 blankets	2.5 lb (1.1 kg)
46-ES	Roll-up vinyl	46 in (1168 mm)	70 in x 55 in (1778 mm x 1397 mm)	1-4 blankets	4 lb (1.8 kg)
P2-ES	Canister	36 in (914 mm)	5 in x 37 in (127 mm x 940 mm)	1-2 blankets	2 lb (0.9 kg)
P3-ES	Canister	36 in (914 mm)	6 in x 37 in (152 mm x 940 mm)	1-3 blankets	3 lb (1.4 kg)
P4-ES	Canister	36 in (914 mm)	7 in x 37 in (178 mm x 940 mm)	1-4 blankets	3.5 lb (1.6 kg)
P4H-ES	Canister	36 in (914 mm)	7 in x 37 in (178 mm x 940 mm)	1-4 blankets	3.5 lb (1.6 kg)
P6-ES	Canister	36 in (914 mm)	9 in x 37 in (229 mm x 940 mm)	1-6 blankets	5 lb (2.3 kg)



22



P4H



## TESTING

ASTM F712 TYPICAL ELECTRODES FOR TESTING PLASTIC GUARD EQUIPMENT			
Types of guards	Energized inner electrode for all tests <sup>A</sup>	Outer ground electrode <sup>A</sup> proof test	Outer ground electrode <sup>A</sup> flashover and leakage tests
Line guards and line guard connectors	Round metal tube or bar	Complete electrode <sup>B</sup> shall be spaced back from openings through which the energized electrode protrudes during the test only as necessary to avoid flashover. Therefore, the entire area of each cover shall be tested as nearly as practical.	4 x 6 in Flexible conductive pad placed alternately on all exterior surfaces and across conductor opening of guard and assembled guard system joints spaced back from openings through which the energized electrode protrudes during the test only as necessary to avoid flashover at outer ends.
Insulator covers and dead-end covers	Maximum conductor, hardware and insulator assembly for which rated or similar mock-up including mandrel <sup>C</sup> of conductive material approximate. <sup>D</sup>		
Pole guards, ridge pin and switch blade covers	<sup>E</sup> Round metal tube, fabricated mandrel <sup>C</sup> or cluster small metal tubes. <sup>D</sup>		
Arm guards Cutout covers	Round or rectangular metal tube or fabricated madre <sup>D,C</sup> Largest cutout with bare leads covered with equal rated line hose. Or similar mock-up including mandrel <sup>C</sup> of conductive material. <sup>D</sup>		
Structural barrier	Rectangular metal sheets approximately 3 mm (0.06 in) thick, having smoothly rounded edges and corners, have been found to be satisfactory for this purpose. Also satisfactory are wet felt or sponge-top electrodes.		

# INSULATING PLASTIC GUARDS AND COVERS

Guards and covers are intended for brush contact applications. All guards can be coupled together to cover any length required.

Guards and covers are available in three different grades: Grade 1 with hot stick handles attached for application and removal, Grade 2 with eye fittings for standard shotgun sticks and Grade 3 without eye fittings. Guards are designed to nest within each other for storage.

The guards and covers are made from two different orange thermoplastics: Type I is an ABS standard cold weather high impact plastic and Type III is an ABS/PVC weather resistant material that offers advantages in tensile and impact strength, hardness, UV stability and flame resistance.

**ALWAYS FOLLOW YOUR COMPANY'S SAFETY PROCEDURES.**

<sup>A</sup> Moistened electrodes may be secured with rubber straps or blanket pins. Pressure-sensitive tape is helpful in securing dry metal foil electrodes.  
<sup>B</sup> Suitable materials include: metal foil or screen; tap water-moistened sponge sheeting, or blanket made of wool, or similar material including synthetics.  
<sup>C</sup> Thin metal sheet or screen wire secured on wood frames make suitable electrodes. Carved synthetic sponge moistened with tap water is suitable for small forms.  
<sup>D</sup> The dimensions of the mandrel are to approximate the maximum size of equipment to which the guard system is to be applied.  
<sup>E</sup> Metal canisters made for storing rubber blankets make suitable electrodes for pole guard tests.



## INSULATING PLASTIC GUARDS AND COVERS

**Guards and covers** are intended for brush contact applications. All guards can be coupled together to cover any length required.

Guards and covers are available in three different grades: Grade 1 with hot stick handles attached for application and removal, Grade 2 with eye fittings for standard shotgun sticks and Grade 3 without eye fittings. Guards are designed to nest within each other for storage.

The guards and covers are made from two different orange thermoplastics: Type I is an ABS standard cold weather high impact plastic and Type III is an ABS/PVC weather resistant material that offers advantages in tensile and impact strength, hardness, UV stability and flame resistance.

### ALWAYS FOLLOW YOUR COMPANY'S SAFETY PROCEDURES

MINIMUM FLASHOVER TEST <sup>A</sup>					
	Rating, kV	Max Use 60 Hz	Min Flashover Voltage Test f-Ground kV		Criteria
	0-0 <sup>A</sup>	0-Ground	60 Hz	DC	
2	14.6	8.4	14	20	No flashover other than momentary as a result of too-close spacing of electrode
3	26.4	15.3	25	35	
4	36.6	21.1	34	48	
5	48.3	27	43	61	
6	72.5	41.8	67	95	

<sup>A</sup> Cover-up materials are tested at values greater than the maximum use phase to ground values. The maximum use phase to phase values relate to guarded phase to guarded phase. The units are not rated for bare phase to guarded phase potentials.

Reprinted, with permission, from ASTM International, 100 Barr Harbor Drive, West Conshohocken, PA 19428. A copy of the complete standard may be obtained from ASTM, www.astm.org

## CROSSARM GUARDS

**Crossarm guards** are available in two different styles: the 1370 -ES pin type and the 1371-ES post type. They are used to prevent tie wires from contacting crossarms during hot line operations. Two different tie downs are provided: a neoprene and a polypropylene rope. Both are secured in the slots provided in the eye fitting. The post type model has an automatic gap closer which covers the insulator slot opening over the end of the arm.

The Slide-On Crossarm Guard 736PH-ES is applied by sliding the cover on to the arm from the end using the shotgun eye until the unit locks onto the insulator pins. The cover overlaps on top and has notches to ease application and removal.

Both of these guards are made from orange Type I ABS cold weather high impact plastic. These guards have a voltage rating of 36.6 kV\*.

CROSSARM GUARDS						
Item #	Description	Class	Dimensions in	Dimensions mm	Weight ea	
					lb	kg
1370-ES	Crossarm or pin type guard	4	9 x 9 x 25.5 in	229 x 229 x 648 mm	5.7 lb	2.6 kg
1371-ES	Crossarm or post type guard	4	Fits crossarm: 5 x 6 in	Fits Crossarm: 127 x 152 mm	6 lb	2.7 kg
736PH-ES	Slide-on crossarm guard	4	7 I.D. x 36 in	178 I.D. x 914 mm	4.5 lb	2 kg

\*Guarded Ø to Guarded Ø. **ALL GUARDS ARE TESTED TO ASTM F712**

## PLASTIC GUARD EQUIPMENT

Rubber insulating equipment is realistically limited to Class 4 material in the design specification standards. Plastic guard equipment has been designed to go beyond these voltages and provide a satisfactory degree of worker protection. Major differences exist in use criteria between the rubber and the plastic guard equipment. Each glove, sleeve or other article of rubber insulating equipment has a given safety factor for the phase to phase voltage on which it may be used and the class or proof voltage at which it is tested. Plastic guard equipment; however, is designed to provide a satisfactory safety factor only when used in a phase-to-ground exposure. If exposure is phase-to-phase, then a satisfactory safety factor is only provided if the exposure is covered-phase-to-covered-phase.



736PH-ES



1370-ES



1371-ES



## AIR GAP® POLE GUARDS

**Pole Guards** are installed before setting new poles to guard against accidental line contact. They also guard against pole contacts by personnel working in insulating aerial buckets or on platforms. Pole Guards are made from orange, Type I ABS, cold weather, high impact thermoplastic. Salisbury Pole Guards feature the unique Air Gap® design. Uniformly spaced dimples minimize the amount of surface area contacting the pole. This provides added insulation to keep electrical leakage to a minimum. When two pole guards are used to cover longer lengths, the Air Gap® dimples nest together "locking" the two together with ample overlap. This is an exclusive feature to Salisbury Pole Guards. The Air Gap® design also allows for air flow between it and the pole minimizing moisture condensation and contamination buildup.

All Salisbury Pole Guards include drilled rope handles for easy application. Pole Guards should be used for brush contact. The opening should face away from possible line contacts, whenever possible. Pole Guards should be stored indoors to avoid prolonged exposure to UV rays and can be cleaned with a warm detergent solution.



Class 5 Air Gap® pole guards 29025-ES



The 21936-ES pole guard includes cut-out to allow clearance for a line post insulator base which is mounted to a utility pole.

2856-ES

POLE GUARDS						
Item #	Description	Class	Type	Diameter x Length		Weight ea lb (kg)
				in x ft	cm x cm	
2854-ES	Pole guard	4	I	6 in x 4 ft	15.2 cm x 121.9 cm	7.1 lb (3.2 kg)
2856-ES	Pole guard	4	I	6 in x 6 ft	15.2 cm x 182.9 cm	10.7 lb (4.9 kg)
1385-ES	Pole guard	4	I	9 in x 1 ft	22.9 cm x 30.5 cm	2.3 lb (1.1 kg)
1386-ES	Pole guard	4	I	9 in x 2 ft	22.9 cm x 61 cm	4.6 lb (2.1 kg)
1356-ES	Pole guard	4	I	9 in x 3 ft	22.9 cm x 91.4 cm	6.9 lb (3.1 kg)
1357-ES	Pole guard	4	I	9 in x 4 ft	22.9 cm x 121.9 cm	9.2 lb (4.2 kg)
2496-ES	Pole guard	4	I	9 in x 6 ft	22.9 cm x 182.9 cm	13.8 lb (6.3 kg)
2461-ES	Pole guard	4	I	12 in x 1 ft	30.5 cm x 30.5 cm	2.7 lb (1.3 kg)
2462-ES	Pole guard	4	I	12 in x 2 ft	30.5 cm x 61 cm	5.3 lb (2.4 kg)
2464-ES	Pole guard	4	I	12 in x 4 ft	30.5 cm x 121.9 cm	10.7 lb (4.9 kg)
2466-ES	Pole guard	4	I	12 in x 6 ft	30.5 cm x 182.9 cm	16 lb (7.3 kg)
29024-ES	Pole guard	5	I	9 in x 1 ft	22.9 cm x 30.5 cm	2.3 lb (1.1 kg)
29023-ES	Pole guard	5	I	9 in x 2 ft	22.9 cm x 60.9 cm	4.6 lb (2.1 kg)
29021-ES	Pole guard	5	I	9 in x 4 ft	22.9 cm x 121.9 cm	9.2 lb (4.2 kg)
2486-ES	Pole guard	5	I	9 in x 6 ft	22.9 cm x 182.9 cm	13.8 lb (6.3 kg)
29028-ES	Pole guard	5	I	12 in x 1 ft	30.5 cm x 30.5 cm	2.7 lb (1.3 kg)
29027-ES	Pole guard	5	I	12 in x 2 ft	30.5 cm x 60.9 cm	5.3 lb (2.4 kg)
29026-ES	Pole guard	5	I	12 in x 3 ft	30.5 cm x 91.4 cm	8 lb (3.6 kg)
29025-ES	Pole guard	5	I	12 in x 4 ft	30.5 cm x 121.9 cm	10.7 lb (4.9 kg)
2478-ES	Pole guard	5	I	12 in x 6 ft	30.5 cm x 182.9 cm	16 lb (7.3 kg)

**ALL GUARDS ARE TESTED TO ASTM F712**

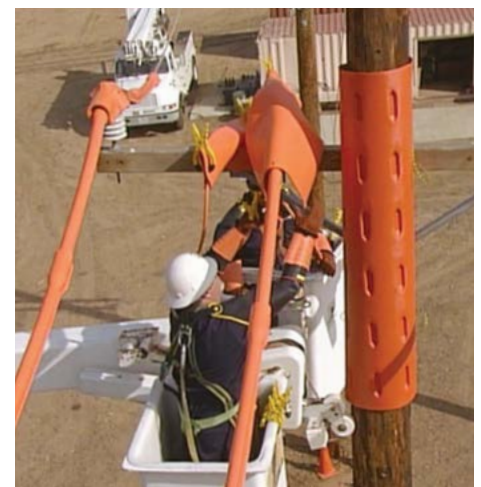

Strong memory improves grip when applied to the utility pole. The pole guard has high impact properties suitable for cold weather service.

## VERSA® AND LINK GUARDS®

Versa and Link guards make use of air as well as the dielectric strength of plastic to provide total insulating value. Both guards have a 7 in diameter and a hook shaped inner lip to keep the guard in place.

### VERSA GUARDS

Versa guards, with a voltage rating of 36.6 kV\*, are designed so that two guards can be coupled together to cover most 13 kV single and double arm, pin and post constructions. A lighter 47 in version (2389-ES) of the standard 4.5 ft Versa Guard is available in a Type III ABS/PVC weather resistant material.

### LINK GUARDS

Link guards, with a voltage rating of 72.5kV\*, have inner and outer shells that run full length to include male and female couple ends. Two guards connected provide four overlapping thicknesses of plastic plus air at a joint.

### TEE CONNECTORS

Tee connectors are used on horizontal and vertical posts and suspension insulator strings when plastic line guards are used on the conductor. Made from Type I, ABS plastic with eye fittings, the connector accommodates the male end of a guard. Available in two ratings: 72.5 kV\* and 48.3 kV\*. Accepts 34.5 kV pin insulators along with post and insulator strings.

VERSA GUARDS® - 3.92 FT (1.19 M)						
Item #	Description	Material	Class	Type	Grade	Weight ea lb (kg)
2389-ES	Versa guard® w/4 ft stick	ABS/PVC	4	III	1	6.1 lb (2.8 kg)
VERSA GUARDS - 4.5 FT (1.37 M)						
1686-ES	Versa guard® w/eye	ABS	4	I	2	8.8 lb (4 kg)
1687-ES	Versa guard® w/4 ft stick	ABS	4	I	1	10.8 lb (4.9 kg)
2373-ES	Versa guard® w/eye	ABS/PVC	4	III	2	8.8 lb (4 kg)
LINK GUARDS - 4.5 FT (1.37 M)						
1680-ES	Link guard® w/eye	ABS	6	I	2	10.5 lb (4.8 kg)
2475-ES	Link guard® w/eye	ABS/PVC	6	III	2	10.5 lb (4.8 kg)
TEE CONNECTORS						
2224-ES	20 tee connector w/eye	ABS	6	I	2	7.8 lb (3.5 kg)

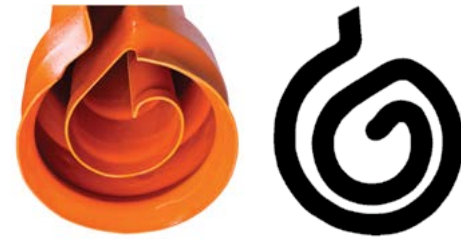

Versa guards and link guard cross section



1680-ES

2475-ES

## LIGHTWEIGHT CONDUCTOR COVERS

Lightweight Conductor Covers are ideal to cover long spans when weight is a consideration. They can be applied when wearing rubber gloves or with a fiberglass hotstick. Available with an eye for application with clampsticks. These covers have a voltage rating of 26.4 kV\*. The inside diameter is 2 in. This product can connect with Salisbury 1.5 in (38.1 mm) I.D. Class 3 or 4 flexible cover-up equipment.

The 21826-ES Lightweight Conductor Cover is a six foot 36.6 kV\* class 4 rated cover. It is applied using rubber gloves when following appropriate company work rules. The inside diameter is 3 in making it useful on a wide range of conductor sizes.

The unique "connector-stop" molded into one end prevents covers from overlapping during installation. This eliminates wasted time when trucks have to be moved to reconnect sections that did not couple correctly. This cover is also compatible with Salisbury 1.5 in I.D. Class 3 or 4 flexible rubber line hose.

All of our lightweight covers are made from orange Type I high density cross link polyethylene.

26.4 KV GUARDED PHASE TO GUARDED PHASE						
Item #	Description	Class	Type	Length ft (m)	Weight ea lb (kg)	
21172-ES	5 ft Cover with eye	3	I	5 ft (1.5 m)	4 lb (1.8 kg)	
21173-ES	5 ft Cover without eye	3	I	5 ft (1.5 m)	3 lb (1.4 kg)	
21315-ES	5 ft Cover with 4 ft fiberglass stick	3	I	5 ft (1.5 m)	5 lb (2.25 kg)	
36.6 KV GUARDED PHASE TO GUARDED PHASE						
21826-ES	6 ft Cover guard	4	I	6 ft (1.8 m)	6.5 lb (2.95 kg)	
21956-ES	6 ft Cover guard with eye	4	I	6 ft (1.8 m)		



21173-ES



21172-ES



21315-ES



Conductor covers connect easily with either plastic or rubber line hose



21826-ES Unique connector stop



21826-ES



21234-ES adapter eye

\*Guarded Ø to Guarded Ø. ALL GUARDS ARE TESTED TO ASTM F712

\*Guarded Ø to Guarded Ø. ALL GUARDS ARE TESTED TO ASTM F712

## SUBSTATION COVER-UP

Substation cover-up and barrier equipment is used during routine maintenance where accidental contact may occur. This barrier equipment is often used where outages are difficult to reach and the occurrence of accidental contact is high. These covers may be applied with rubber gloves or hot sticks. These covers are made from Type I orange ABS plastic. This equipment is not intended for permanent or semipermanent barrier or insulating applications. The use of these covers is to protect against accidental contact only. These covers are not to be left installed for extended periods of time especially when in contact with both a grounded and energized object.

### BUS GUARDS

Bus guards are easily interlocked with each other. To interlock units, determine the length of bus to be covered. Place one unit on the bus guard then the other, pulling it over the first cover until the dimples interlock at the required length.

### BUS "T" GUARDS

Bus "T" guards interlock two or three bus guards at bus tap "T" connections and 90 degree angles. To interlock units, first position the bus guard. Then, slide the "T" guard over the top and interlock the dimples.

### BUS END GUARDS

Bus end guards cover the ends of a substation bus supported by station post insulators. The slot and insulator grip hole can be easily enlarged in the field with a sharp knife. This cover also has a guide bead for a trim fit.

BUS GUARDS					
Item #	Description	Class	Type	Dimensions in (mm)	Weight ea lb (kg)
1374-ES	Bus guard	4	1	5.25 ft x 9.5 ft x 4.5 ft (133 mm x 241 mm x 1.4 m)	4 lb (1.8 kg)
1375-ES	Bus "T" guard	4	1	5 ft x 15 ft x 25 ft (127 mm x 381 mm x 635 mm)	4 lb (1.8 kg)
9992-35-ES	Bus end guard	4	1	8.5 ft x 12 ft x 24 in (216 mm x 305 mm x 610 mm)	5 lb (2.3 kg)
9992-ES	Bus end guard	3	1	8.5 ft x 12 ft x 24 in (216 mm x 305 mm x 610 mm)	5 lb (2.3 kg)



1374-ES



Bus Guard

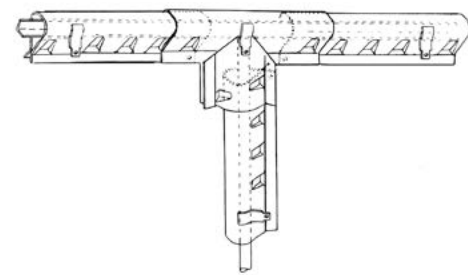
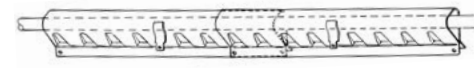

Bus "T" Guard



1375-ES



9992-ES

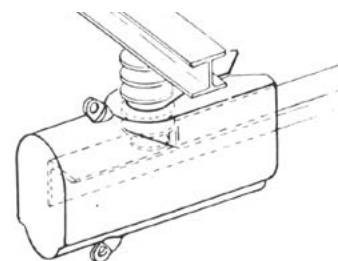

Bus end guard

## SUBSTATION COVER-UP

### SWITCH JAW GUARD & BARRIER

Switch jaw guards insulate the energized upper switch jaw and insulator when work is being done on the switch blade, lower insulator or other de-energized equipment ahead of the open switch. These guards easily slide over the upper insulator on open substation switches and lock over the bus. Jaw Guards are made from Type I UV resistant plastic.

### SWITCH JAW COVER

The 24219 switch jaw cover provides an insulated barrier to the energized upper switch jaw and insulator, when work is being done on the switch blade, lower insulator or other de-energized equipment ahead of the open switch. This guard slides easily over the upper insulator on open substation neutral disconnect cabinet switches and locks over the bus. The 24219 Cover is made from Type I cold weather high impact plastic.

### SWITCH BARRIERS

Switch barriers slide between the last two skirts on the post or pin cap insulators of the substation disconnect switch. This locks the barrier in place. When switches are mounted back to back and work is needed on one switch, the barrier can be placed on the energized switch to form a visible, electrical and mechanical barrier. Work can then be done on the opposite switch or other de-energized equipment.



1376-ES

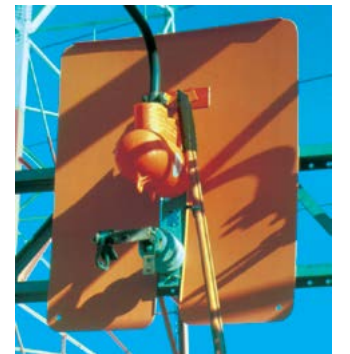

Barrier and switch jaw guard installed on a substation switch.

JAW GUARD					
Item #	Description	Class	Type	Dimensions in (mm)	Weight ea lb (kg)
2418-35-ES	Jaw guard, use w/ switch 8 in	4	1	8 ft x 18 in (203 mm x 457 mm)	4 lb (1.8 kg)
2418-ES	Jaw guard, use w/ switch 8 in	3	1	8 ft x 18 in (203 mm x 457 mm)	4 lb (1.8 kg)
2424-35-ES	Jaw guard, use w/ switch 8 in	4	1	8 ft x 24 in (203 mm x 610 mm)	5 lb (2.3 kg)
2424-ES	Jaw guard, use w/ switch 8 in	3	1	8 ft x 24 in (203 mm x 610 mm)	5 lb (2.3 kg)
1376-ES	Barrier substation switch	4			



24455-ES



2418-ES

\*Guarded Ø to Guarded Ø. ALL GUARDS ARE TESTED TO ASTM F712

\*Guarded Ø to Guarded Ø. ALL GUARDS ARE TESTED TO ASTM F712

## GUARD AND COVER ACCESSORIES

### UNIVERSAL HOT COVER

The universal hot cover is used to provide additional cover-up and clearances. This cover is made from orange Type I polyethylene plastic. The hotstick eye allows this cover to be placed and removed with a shotgun type clamp stick or with rubber gloves. To secure in place, use the elastic tie-down cord. This cover can be used on overhead or underground energized cable terminators, potheads or while inverted, on lightning arrestors. This cover has a 36.6 kV guarded phase to guarded phase rating.

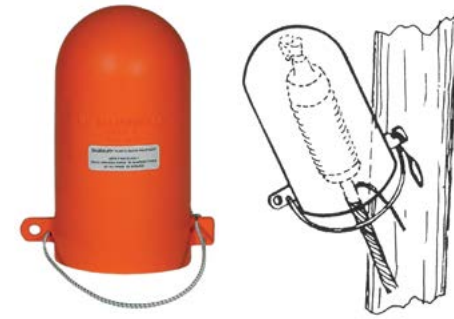

816-ES

### POLE BRACKET AND INSULATOR BASE COVER

The pole bracket and insulator base cover guards against accidental contact with a pole, bracket or insulator base during routine maintenance. It is made from an orange UV resistant Type I polyethylene plastic. The grade 2 hotstick eye allows this cover to be applied and removed with a hotstick or with rubber gloves. It covers metal or fiberglass brackets 8-12 in long and pole mounting plates. This cover also interlocks with a pole insulator. This cover has a voltage rating of 26.4 kV\*.



4333-ES

Pole bracket and insulator base cover

### UNDERGROUND DISTRIBUTION ELBOW COVER

The underground distribution elbow cover covers primary elbows and spade terminals during routine maintenance. It covers up to the face plate and cable connection. This cover is made from orange Type I polyethylene plastic. The hotstick eye allows this cover to be applied and removed with a hotstick. This cover self locks for a secure fit in confined areas. The bead can be trimmed in the field to meet clearance requirements. This cover has a voltage rating of 26.4 kV\*.



Elbow

4314-ES



Elbow cover application

COVERS					
Item #	Description	Class	Type	Dimensions in (mm)	Weight lb (kg)
816-ES	Hot cover	4	I	8 in x 16 in (203 mm x 406 mm)	2.5 lb (1.1 kg)
4314-ES	Underground distribution elbow cover	3	I	15 in x 14.25 in (381 mm x 362 mm)	2 lb (0.9 kg)
4333-ES	Pole bracket & insulator base cover	3	I	20 in x 25 in (508 mm x 635 mm)	2.5 lb (1.1 kg)

## GUARD AND COVER ACCESSORIES

### BAGS FOR LINE GUARDS AND POLE GUARDS

Bags for line guards and pole guards come in two different sizes and can hold two nested line guards.

All of these bags are made from soil-resistant, vinyl-coated nylon and are equipped with a drawstring and mail bag lock.

### APPLICATOR EYE KIT

The applicator eye kit is used to apply a new or extra shotgun eye where needed. If a bus or "T" guard needs to be shortened or inverted, this kit allows modifications to be made. Clear PVC pipe cement may be used to secure the eye. Directions are included.

### INSULATING BARRIER SHEET

The insulating barrier sheet can be used to create barriers in the field. This sheet is made from Type I ABS plastic and can be worked with ordinary hand tools, saws, tin snips and drills. It can also be hot formed using a heat gun. For example, this sheet can be bent at right angles over a table top to produce flanges for joining with other parts. Pipe adhesive can be used to join to other parts. The rated puncture is 50kV. This sheet is not intended for permanent or semipermanent barrier or insulating applications. It should be used for accidental brush applications. The 2842 barrier material meets the requirements of ASTM F712, 9.1.1 Type 1 Guards. The final application and classification of the barrier/cover is the responsibility of the user.

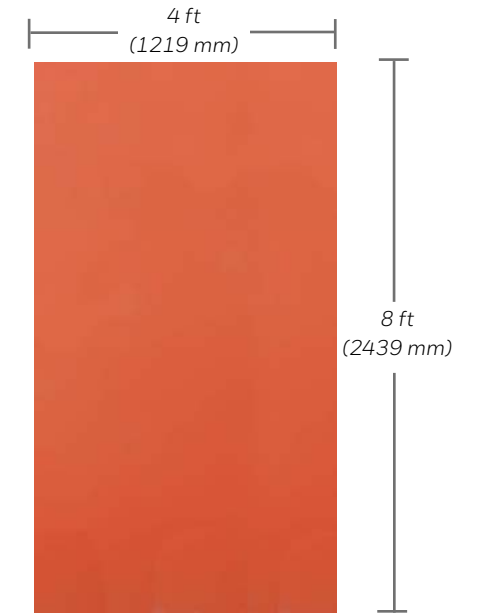

1378-ES

### BAGS & ACCESSORIES

Item #	Description
1841-ES	Red vinyl bag - fits 2 ft to 6 ft Line Guards
1871-ES	Red vinyl bag - fits 2 ft to 12 in Line Guards
2842-ES	Barrier sheet - 4 ft x 8 ft
1378-ES	Eye kit



1871-ES Pole guard bag



1871-ES

\*Guarded Ø to Guarded Ø. ALL GUARDS ARE TESTED TO ASTM F712



**BETTER  
PROTECTED  
BETTER  
PREPARED**

# OUTAGE PROTECTION

Animals cannot be stopped, but these products can prevent them from causing costly outages. It's only a matter of time before an animal caused outage happens. Salisbury's Outage Protection Product Line includes the essential items you need to protect yourself from costly outages.

All of these products are completely made from material that is resistant to the effects of UV and ozone. Designed to withstand the test of time, sun and weather, to keep you protected longer.

**Designed for linemen. These lightweight products are easy to use and install.**

## FAQ

**Q: Why should I use Outage Protection?**

**A:** The cost of animal caused outages to the utilities is preventable. Animals cause power outages daily, creating time lost to utilities. Salisbury offers an easy solution to this expensive problem.

Note: Outage protection is not to be used as Personal Protective Equipment (PPE).

## 20 KV SILICONE STINGER COVERS

### SALISBURY ADVANTAGE

The Salisbury stinger covers SC and SCS series are extruded in EPDM or silicone rubber and designed for field installation over bare conductors. The covers provide electrical insulation and protection for phase to phase and phase to ground flashover that is caused by wildlife contact. Accepted by (RURAL Utility Services) RUS.

### HIGH VOLTAGE WILD LIFE OUTAGE PROTECTION CONDUCTOR COVER

New silicone stinger covers are suitable for applications up to 20 kV phase to ground. The new cover design offers improved electrical insulation for phase to phase and phase to ground protection. The covers are extruded with a tapered profile specifically designed to overlap onto itself and over the conductor further improving the dielectric properties and conductor protection. The new stinger covers are manufactured using silicone rubber which has excellent high and low temperature properties. They are designed to resist the test of time, sun and weather while keeping assets protected.

The stinger cover can be installed without disconnecting the lead wire from the bushing. Stinger covers are available in six diameters and are easily cut down to the length needed in the field.

### SILICONE STINGER COVER FEATURES

- Suitable for applications up to 20 kV phase to ground
- Six sizes available & will fit conductors up to 1.25 in dia.
- Improved pliability at greater temperature ranges -40° C to 200° C
- Excellent UV & Ozone resistance
- Unique design profile
- Excellent conductor protection and fit
- Easy slip on installation, no tool required
- Flexibility of covers facilitate overhead installation on tight bends  
Ideal for substation and distribution applications



## 20 KV SILICONE STINGER COVERS

### SPECIFICATIONS

PHYSICAL PROPERTIES		
Property	Specifications	Test method
Material	Silicone rubber	N/A
Color	Gray	N/A
Tensile Strength	600 PSI min	ASTM D-638
Elongation	≥200%	ASTM D-412
Durometer	60 ±8	ASTM D2240
Temperature	-40°C to 200°C	N/A
Tear resistant	75 PPI min	N/A
Ozone resistant	No crack @ 40C°(107°F), 70 hrs	N/A
UV resistant (ASTM G-26)	Yes	N/A
Flammability rating (provided by material supplier)	UL 94 V-0	N/A
Comparative tracking Index	> 500 V	ASTM D-3638
Low temperature torsional stiffness	Pass	ASTM D 1053-92E

PHYSICAL PROPERTIES		
Property	Specifications	Test method
Dielectric strength	≥ 300 V/mil (118 kV/cm)	ASTM D149
Flashover rating	Refer to ordering information	ASTM D1050 18.2 electrical flashover test
Volumetric resistivity	≥1 x 10 <sup>14</sup> Ohm/cm	N/A

ORDERING INFORMATION						
Item #	I.D. in (mm)	Thickness in (mm)	Flashover Test		Quantity ft (m)	Weight Ea. lb (kg)
			Phase to Ground (kV)	Phase to Phase (kV)		
38-25SCS-ES	0.375 in (9.5mm)	0.2 in (5.08 mm)	20	35	25 ft (7.62 mm) coil	10 lb (4 kg)
38-50SCS-ES	0.375 in (9.5 mm)	0.2 in (5.08 mm)	20	35	50 ft (15.24 mm) coil	20 lb (9 kg)
50-50SCS-ES	0.5 in (12.7 mm)	0.2 in (5.08 mm)	20	35	50 ft (15.24 mm) coil	23 lb (10 kg)
58-25SCS-ES	0.625 in (15.9 mm)	0.2 in (5.08 mm)	20	35	25 ft (7.62 mm) coil	13 lb (5 kg)
58-50SCS-ES	0.625 in (15.9 mm)	0.2 in (5.08 mm)	20	35	50 ft (15.24 mm) coil	26 lb (11 kg)
34-25SCS-ES	0.75 in (19.1 mm)	0.2 in (5.08 mm)	20	35	25 ft (7.62 mm) coil	16 lb (7 kg)
100-25SCS-ES	1 in (25.4 mm)	0.2 in (5.08 mm)	20	35	25 ft (7.62 mm) coil	18 lb (8 kg)
125-25SCS-ES	1.25 in (31.8 mm)	0.2 in (5.08 mm)	20	35	25 ft (7.62 mm) coil	18 lb (8 kg)



Enhanced cover profile allows for easy "slip on" installation.

NO AIR GAP OR CUTS ALONG THIS EDGE.

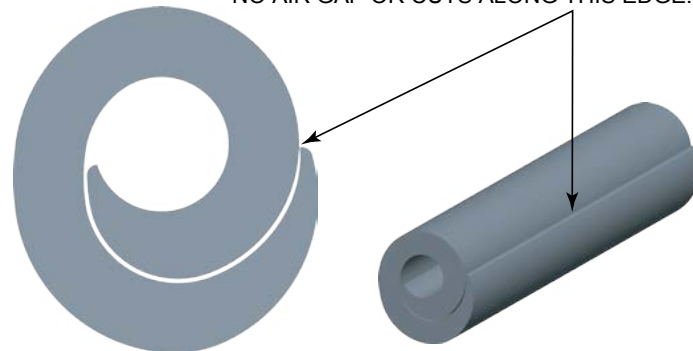

## 10-15 KV EPDM STINGER COVERS

### 10 KV-15 KV WILD LIFE OUTAGE PROTECTION CONDUCTOR COVER

EPDM Silicone stinger covers are suitable for applications up to 15 kV phase to ground. The stinger covers are made with EPDM rubber, which is UV and ozone resistant and is applied over the conductor. They are designed to resist the test of time, sun and weather to keep the assets protected. The stinger cover can be installed without disconnecting the lead wire from the bushing. Stinger covers are available in three diameters and are easily cut down to the length needed in the field.

Stinger covers are track resistant and made from ozone and UV resistant SALCOR® elastomer in a grey color. The covers are proven to provide years of reliable service either independently or when used with bushing covers.

### EPDM STINGER COVER FEATURES

- Suitable for applications up to 15 kV phase to ground
- Three sizes and multiple packaging options available & will fit conductors up to 0.75 in (19.05 mm) dia.
- Flexibility of covers facilitate overhead installation on tight bends. Ideal for substation and distribution applications.
- Excellent UV & Ozone resistance

#### PHYSICAL PROPERTIES

Property	Specification	Standard
Material	EPDM	N/A
Color	Gray	N/A
Tensile Strength	600 PSI	ASTM D412
Elongation	500%	ASTM D412
Durometer	78	ASTM D2240

#### ELECTRICAL PROPERTIES

Property	Specification	Standard
Dielectric Testing	486 V/mil (191.3 kV/cm)	ASTM D149
Flashover Rating	Refer to ordering information	ASTM D1050

#### ORDERING INFORMATION

Item #	I.D. in (mm)	Dimensions ft (m)	Flashover test		Quantity	Weight lb (kg)
			Phase to ground (kV)	Phase to phase (kV)		
38-2SC-ES	0.375 in (9.5 mm)	2 ft (0.61 m)	10.5	18	25 pcs	9.5 lb (4.3 kg)
38-50SC-ES	0.375 in (9.5 mm)	50 ft (15.3 m)	10.5	18	1 coil	9.5 lb (4.3 kg)
38-100SC-ES	0.375 in (9.5 mm)	100 ft (30.5 m)	10.5	18	1 coil	16 lb (7.25 kg)
58-12SC-ES	0.625 in (15.9 mm)	12 ft (3.7 m) coil	12.5	22	4 pcs	22 lb (10 kg)
58-50SC-ES	0.625 in (15.9 mm)	50 ft (15.3 m) coil	12.5	22	1 pc	21 lb (9.5 kg)
58-100SC-ES	0.625 in (15.9 mm)	100 ft (30.5 m) coil	12.5	22	1 pc	45 lb (20.5 kg)
34-12SC-ES	0.75 in (25.4 mm)	12 ft (3.7 m) coil	14.9	26	4 pcs	22 lb (10 kg)
34-25SC-ES	0.75 in (25.4 mm)	25 ft (7.6 m) coil	14.9	26	2 pcs	22 lb (10 kg)



EPDM Stinger Cover



Stinger Cover Cross-section

## INSTANT INSULATION

Instant Insulation may be installed as a permanent cover to protect against outages caused by weather, trees and animals. Instant Insulation resists ozone and ultraviolet deterioration while remaining flexible even at sub-zero conditions.

Instant Insulation is made of orange or grey SALCOR® elastomer. Instant Insulation is sold in three diameters, each 12 feet in length. Each include six nylon UV resistant bar-lock cable ties to secure it to the conductor.

Instant Insulation can be installed using the 2494 Applicator. To install, insert one end of the Instant Insulation into the applicator prongs, then roll and coil the insulation as shown. Secure the coil end with tape, cable ties, or rubber bands. To install, release the secured end and the Instant Insulation will unroll and enclose the conductor.

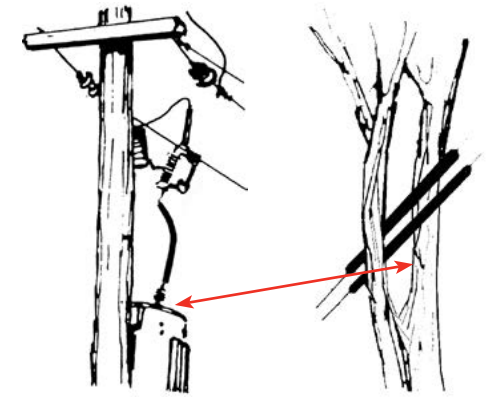

Instant Insulation

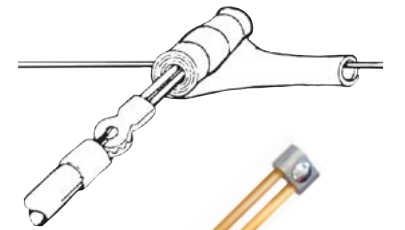

2494-ES



1127-ES

NOTE: Instant insulation is currently rated at 20 kV per ASTM D1050 18.2 Electrical flashover test. Material dielectric strength is of 486 V/mil. effective thickness is 0.15 in to 0.2 in (3.81 mm to 5.08 mm) when installed.

#### INSTANT INSULATION 12' / 3.6M LONG

Item #	Dimensions in (mm)	Flashover test		Length ft (m)	Color	Weight lb (kg)
		Phase to ground (kV)	Phase to phase (kV)			
1127-ES	0.75 in I.D. (19 mm I.D.)	20	34.5	12 ft (3.6 m)	Grey	7 lb (3.2 kg)
1128-ES	0.75 in I.D. (19 mm I.D.)	20	34.5	12 ft (3.6 m)	Orange	7 lb (3.2 kg)
1129-ES	1 in I.D. (25 mm I.D.)	20	34.5	12 ft (3.6 m)	Grey	8 lb (3.6 kg)
1130-ES	1 in I.D. (25 mm I.D.)	20	34.5	12 ft (3.6 m)	Orange	8 lb (3.6 kg)
1131-7-ES	1.25 in I.D. (32 mm I.D.)	20	34.5	7 ft (2.1 m)	Grey	
1131-ES	1.25 in I.D. (32 mm I.D.)	20	34.5	12 ft (3.6 m)	Orange	10 lb (4.5 kg)
2494-ES	Universal Hotstick Applicator			1 ft (0.5 m)		



## RISKS OF AN ARC FLASH

Arc flashes can be generated by various conditions including mechanical breakdowns or failure of electrical circuits, current overloads or accidental contacts.. This explosive condition includes a broad spectrum of electromagnetic energy, plasma, fragments of damaged equipment and molten metal from the destruction of conductors at the point of the arc flash.

An arc flash event can generate temperatures reaching 35,000°F – that is four times hotter than the surface of the sun. The molten copper that is generated from an arc flash often exceeds 2,000°F and rapidly expands from the source of the arc event, often at a great distance from it. Between the super-heated plasma, the molten copper and the overall force of the arc event, everyone in its vicinity is at serious risk of injury or even death. The effects of an arc flash can be devastating unless you are properly protected.

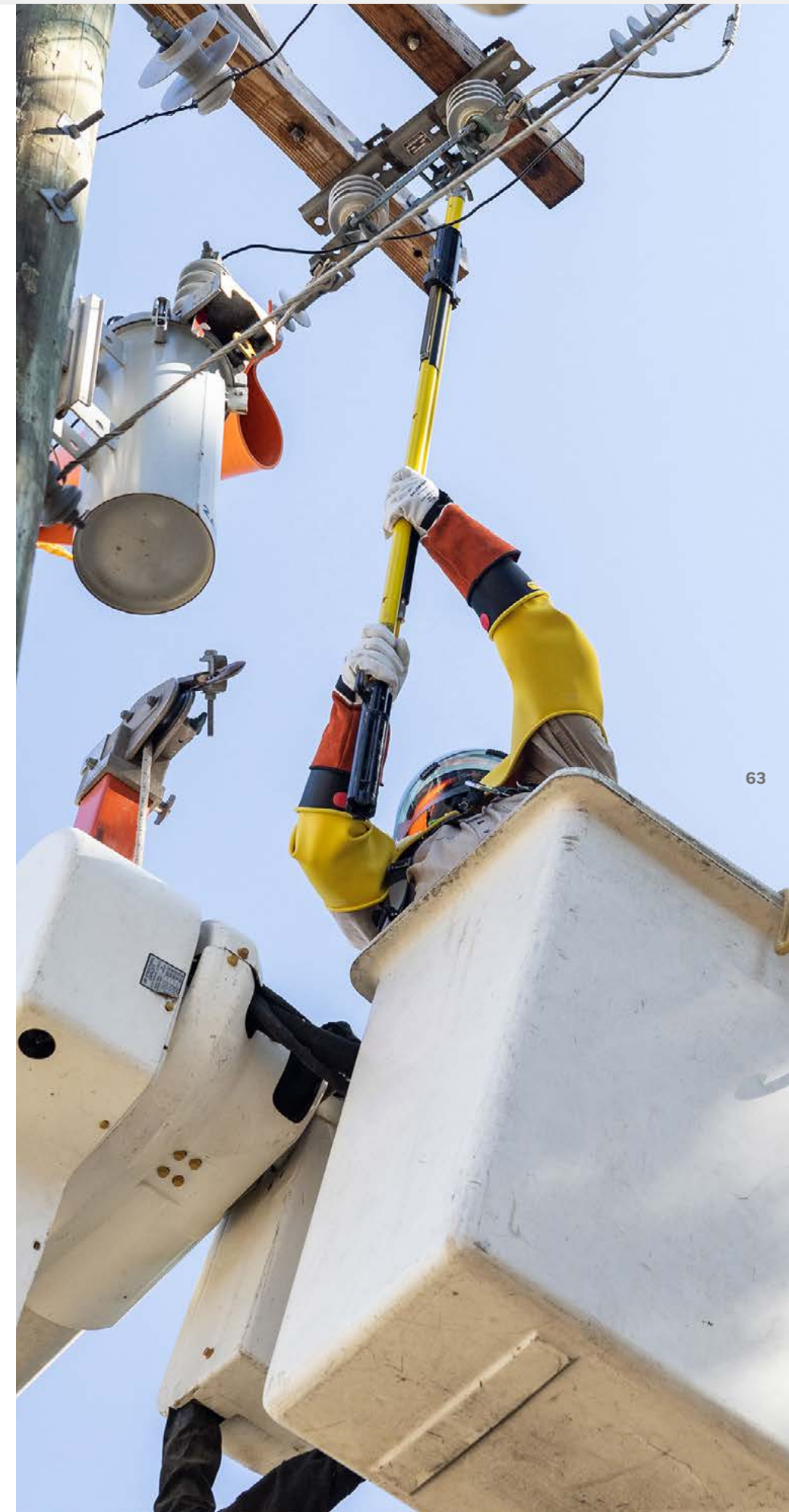

# ARC FLASH

Arc Flash is a dangerous condition associated with the release of massive amounts of energy produced by an electrical arc.

Honeywell is your complete source for personal electrical safety products that comply with NFPA 70E requirements and OSHA regulations. This has enabled Honeywell Salisbury to become the world-wide leader in electrical safety equipment - Including the revolutionary PrismShield™ Plus.



## STANDARDS RELEVANT TO ARC FLASH GARMENTS

Because electrical work poses serious potential hazards for workers, the Occupational Safety and Health Administration (OSHA) has extensive regulations that employers and employees must adhere to in order to keep workers safe in accordance with the National Electric Code (NEC). Electrical Safety PPE is mandatory, and OSHA is the governing body that ensures employers comply. Salisbury electrical safety products are tested and comply with ASTM (American Society for Testing and Materials) standards and regulations, as well as ANSI (American National Standards Institute).

Arc-rated clothing, also known as arc flash-resistant clothing, is specially designed protective apparel engineered to safeguard workers from the thermal and heat-related hazards associated with electric arc flashes. Arc-rated clothing is crafted using flame-resistant materials that resist ignition, prevent burning, and minimize injury to the wearer.

### SALISBURY ASSESSMENT SOLUTIONS HELPS YOU KNOW WHAT YOU NEED TO BE COMPLIANT

Employers must provide all available information that relates to the determination of existing characteristics and conditions. In order to gather this information, employers conduct an arc flash hazard analysis and post information regarding safety in their facility.

#### There are 3 steps to completing an arc flash hazard analysis:

1. Determine the Arc Flash Boundary – The arc flash boundary changes depending on the potential arc flash hazard. The arc flash boundary is calculated to 1.2 calories/cm<sup>2</sup> of incident energy, which is the distance where a worker without appropriate PPE would receive 2nd degree burns. Moving toward the energized and exposed equipment, you'll find the limited approach boundary. Within this boundary, it is still possible to be exposed to a shock hazard which is why PPE should be worn by qualified workers. The area closest to the live, exposed equipment is within the restricted boundary. In order to pass this boundary, you must be a qualified worker with the proper training and PPE.
2. Deciding what PPE is needed for application
3. Labeling equipment – electrical equipment that is likely to require examination, adjustment, servicing or maintenance shall be field marked with a label containing the following
  - a. Normal system voltage
  - b. Arc flash boundary
  - c. At least one of the following:
    - available incident energy, minimum arc rating of clothing, and /or
    - site-specific level of PPE

APPLICABLE STANDARDS/ REQUIREMENTS	
<b>NFPA 70E</b>	Standard for electrical safety in the workplace
<b>ASTM F1506</b>	Standard performance specification for flame resistant and electric arc rated protective clothing worn by workers exposed to flames and electric arcs
<b>ASTM F1959/F1959M</b>	Standard test method for determining the arc rating of materials for clothing
<b>ASTM F2178</b>	Standard test method for determining the arc rating and standard specification for eye or face protective products
<b>ANSI Z87.1</b>	Standard for occupational and educational personal eye and face protection devices

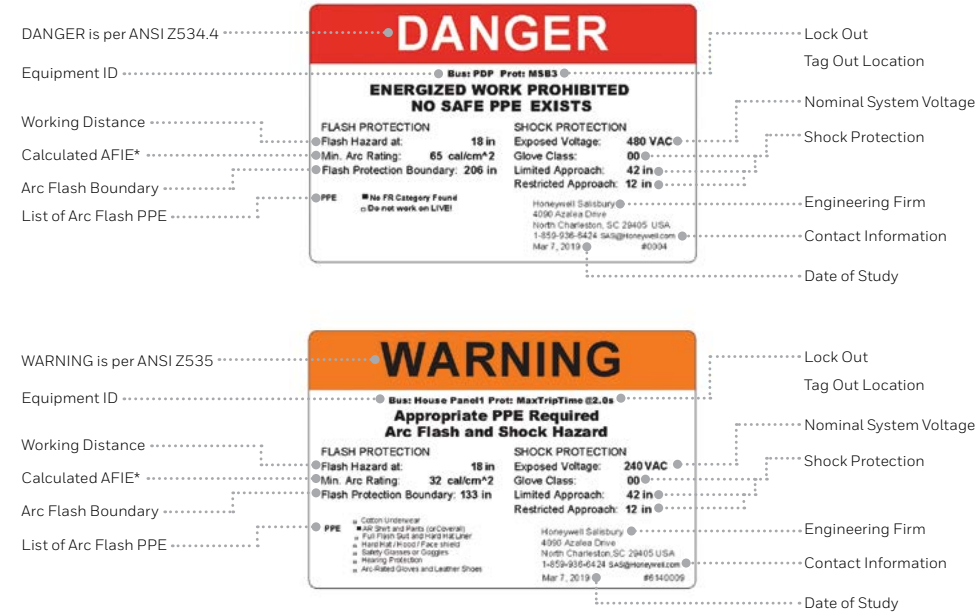
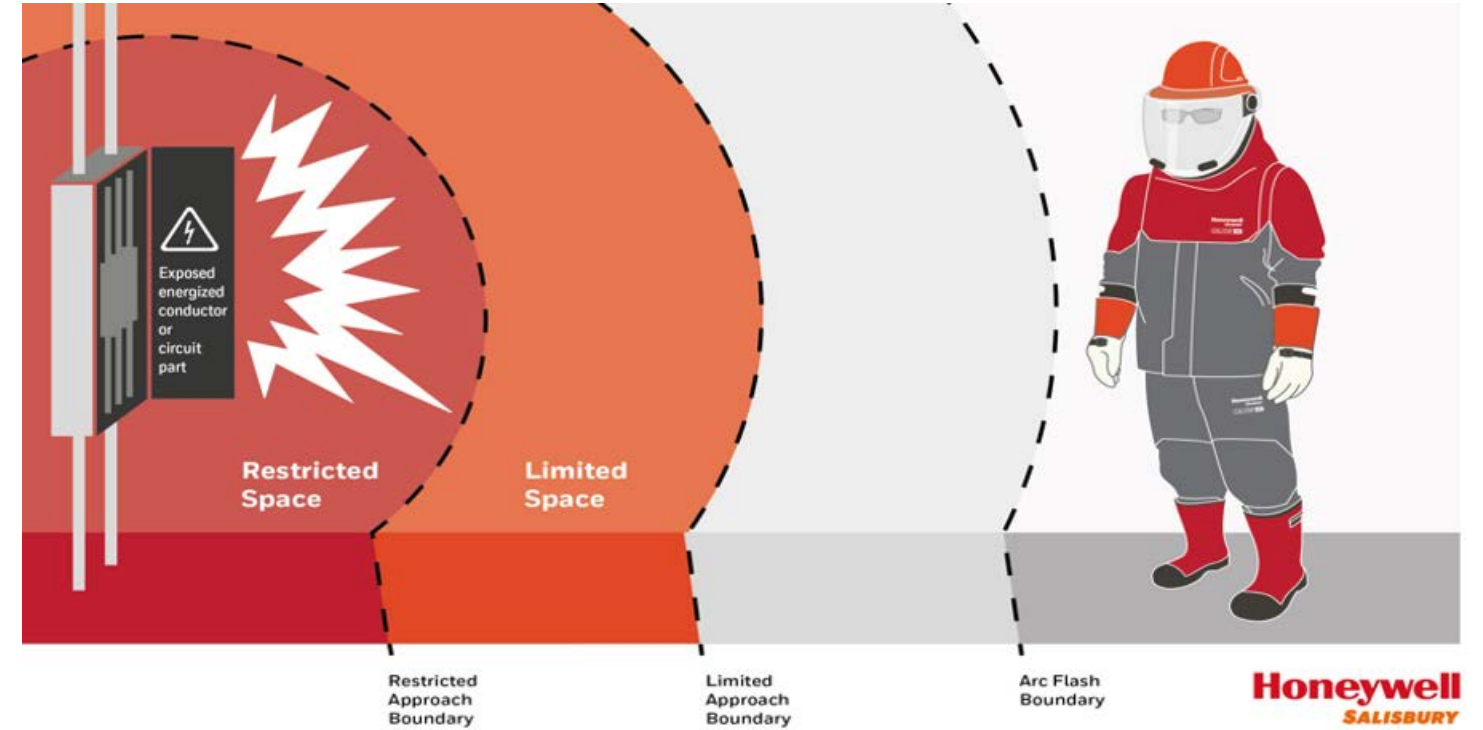

**SALISBURY ASSESSMENT SOLUTIONS (SAS)** is a team of electrical engineers and safety experts offering individualized services to meet your needs for electrical safety compliance and to help you achieve your electrical safety program goals. SAS offers electrical hazard risk assessments, arc flash risk assessments, compliance support, electrical engineering, assistance and support with written electrical safety programs and electrical training. SAS is a customized service that can meet the unique needs of each customer. For more information on Salisbury Assessment Solution, [click here](#).

## ARC FLASH CATEGORIES

Based on the results of the arc flash analysis, employees must wear protective clothing for the corresponding PPE category.

<b>PPE CATEGORY 1</b>	<b>PPE CATEGORY 2</b>	<b>PPE CATEGORY 3</b>	<b>PPE CATEGORY 4</b>
Arc Rating Minimum 4 cal/cm <sup>2</sup>	Arc Rating Minimum 8 cal/cm <sup>2</sup>	Arc Rating Minimum 25 cal/cm <sup>2</sup>	Arc Rating Minimum 40 cal/cm <sup>2</sup>

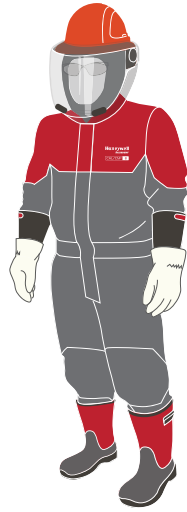

- PPE Needed:**
- Arc rated long sleeve shirt and pants or coverall
  - Arc rated face shield with a hard hat
  - Arc rated balaclava
  - Heavy-duty leather gloves or rubber insulating gloves with protectors
  - Leather or dielectric shoes
  - Safety glasses
  - Hearing Protection



- PPE Needed:**
- Arc rated long sleeve shirt and pants or coverall
  - Arc rated face shield with a hard hat
  - Arc rated balaclava
  - Heavy-duty leather gloves or rubber insulating gloves with protectors
  - Leather or dielectric shoes
  - Safety glasses
  - Hearing Protection



- PPE Needed:**
- Arc rated coverall or pants and coat or bib overalls and coat
  - Arc rated hood with a hard hat
  - Arc rated gloves or rubber insulating gloves with protectors
  - Leather or dielectric shoes
  - Safety glasses
  - Hearing Protection

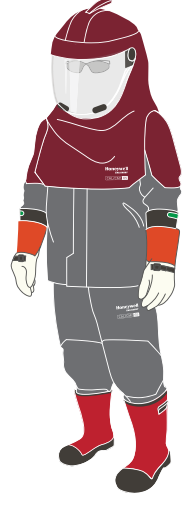

- PPE Needed:**
- Arc rated pants and coat or bib overalls and coat
  - Arc rated hood with a hard hat
  - Arc rated gloves or rubber insulating gloves with protectors
  - Leather or dielectric shoes
  - Safety glasses
  - Hearing Protection

## PRISMESHIELD™ PLUS

While Honeywell Salisbury pioneered the move away from green lenses to less opaque bronze, there was still room for innovation to provide even clearer vision for workers and increase the line of sight.

Building upon PrismShield™ technology, the PrismShield™ Plus face shield is the next iteration in a line of successful products. The use of nanoparticle technology allows for enhanced color differentiation and improved light transmittance while the double curved lens redesign provides superior optical performance and greatly reduces eye strain while wearing the face shield. User comfort is heightened by a venting system allowing fresh air in from the bottom and moisture to escape from the top.

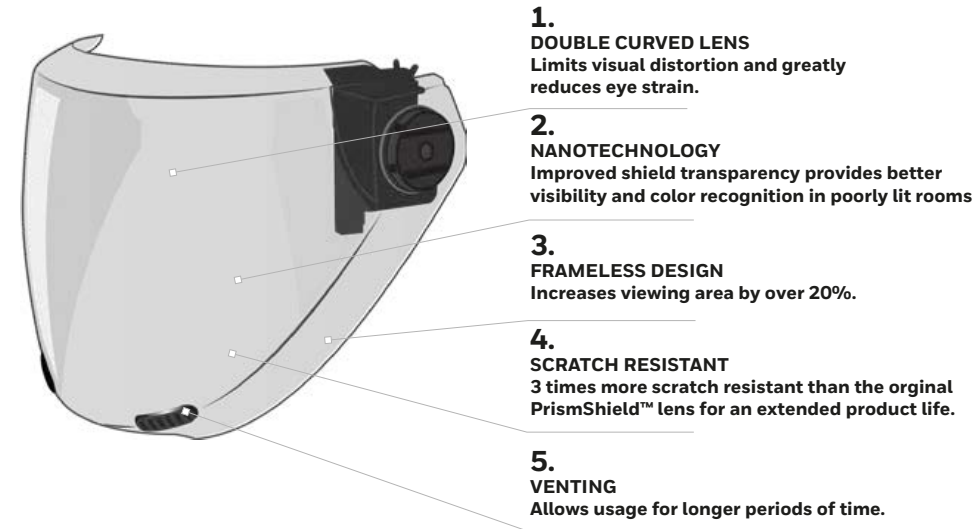

### PROPER COLOR RECOGNITION. PROPER SAFETY.

The Prismshield™ Plus nanoparticle technology allows the full spectrum of light to be transmitted and observed by the user. Therefore, all colors can be observed and clearly identified with the face shields – blues are blue, greens are green.

Compared to the legacy green arc shields from Salisbury, the Prismshield™ Plus transmits 25% more wavelengths, making colors clearer and more visible across the color spectrum. Cutting edge nanotechnology enhances visibility, making colors stand out and be easily identified from each other.

Prismshield™ Plus color recognition makes colors visible where they once were almost indistinguishable. The circles to the right are common when testing for color blindness, the superior performance of the face shield is undeniable.

Color recognition testing showed that using the Prismshield™ Plus gives the same color perception as not wearing a face shield at all.



reddot award 2023 winner

See the difference in color perception between the Prismshield™ Plus and our legacy green lens. Notice the clarity of a PrismShield™ Plus versus the distortion effect of a green lens.



PrismShield™ Plus color spectrum

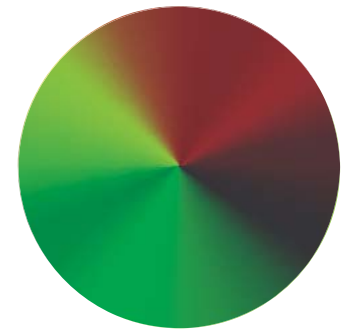

Legacy green color spectrum

## HONEYWELL SALISBURY FACE SHIELDS

Honeywell Salisbury face shields are available in four versions to satisfy every possible need of an electrical or utility line worker:

PRISMSHIELD™ FACE SHIELDS	
Part Number	Description
AS1000-SPL	PrismShield™ 10 Cal/cm <sup>2</sup> face shield
AS1000U-SPL	PrismShield™ 10 Cal/cm <sup>2</sup> face shield for universal hard hats
AS1000FB-SPL	PrismShield™ 10 Cal/cm <sup>2</sup> face shield with full brim assembly
AS1000HAT-SPL	PrismShield™ 10 Cal/cm <sup>2</sup> face shield with North Zone hard hat



**PrismShield™ Face Shield** takes minimum compliance to the next level. Features and benefits you've come to expect from our higher calorie shields are now standard entry level features.

PRISMSHIELD™ PLUS WEIGHT BALANCING FACE SHIELDS	
Part Number	Description
AS1200-PP	PrismShield™ Plus 12 Cal/cm <sup>2</sup> weight balancing face shield
AS1200HAT-PP	PrismShield™ Plus 12 Cal/cm <sup>2</sup> weight balancing face shield with North Zone front brim hard hat
AS1200FB-PP	PrismShield™ Plus 12 Cal/cm <sup>2</sup> weight balancing face shield with full brim assembly
AS1200HAT-FB-PP	PrismShield™ 12 Cal/cm <sup>2</sup> with North Zone full brim hard hat
AS1200U-PP	PrismShield™ Plus 12 Cal/cm <sup>2</sup> for universal front brim hard hats
AS1200-MSA-PP	PrismShield™ Plus 12 Cal/cm <sup>2</sup> weight balancing face shield for MSA V-Gard®
AS2000-PP	PrismShield™ Plus 20 Cal/cm <sup>2</sup> weight balancing face shield
AS2000HAT-PP	PrismShield™ Plus 20 Cal/cm <sup>2</sup> weight balancing face shield with North Zone front brim hard hat
AS2000FB-PP	PrismShield™ Plus 20 Cal/cm <sup>2</sup> weight balancing face shield with full brim assembly
AS2000HAT-FB-PP	PrismShield™ Plus 20 Cal/cm <sup>2</sup> weight balancing face shield with North Zone full brim hard hat
AS2000-MSA-PP	PrismShield™ Plus 20 Cal/cm <sup>2</sup> weight balancing face shield for MSA V-Gard™
AS2000U-PP	PrismShield™ Plus 20 Cal/cm <sup>2</sup> for universal front brim hard hats



**PrismShield™ Plus Weight Balancing Face Shields** reduce neck strain for users which increases user comfort and mobility.

PRISMSHIELD™ PLUS PRO-HOOD	
Part Number	Description
FH8RG-PP	PrismShield™ Plus 8 Cal/cm <sup>2</sup> Pro-Hood
FH12RG-PP	PrismShield™ Plus 12 Cal/cm <sup>2</sup> Pro-Hood
FH20RG-PP	PrismShield™ Plus 20 Cal/cm <sup>2</sup> Pro-Hood
FH40RG-PP	PrismShield™ Plus 40 Cal/cm <sup>2</sup> Pro-Hood
FH40PRG-PP	PrismShield™ Plus 40 Cal/cm <sup>2</sup> Pro-Hood (premium)
FH65PRG-PP	PrismShield™ Plus 65 Cal/cm <sup>2</sup> Pro-Hood (premium)
FH100PRG-PP	PrismShield™ Plus 100 Cal/cm <sup>2</sup> Pro-Hood (premium)

\*Premium refers to use of GlenGuard premium, lightweight fabric



**PrismShield™ Plus Pro-Hood** provides 360-degree protection against the heat and blast released in an arc flash event rated up to 100 calories.

PRISMSHIELD™ PLUS LIFT FRONT HOOD	
Part Number	Description
LFH20RG-PP	PrismShield™ Plus 20 Cal/cm <sup>2</sup> Lift Front Hood
LFH40RG-PP	PrismShield™ Plus 40 Cal/cm <sup>2</sup> Lift Front Hood
LFH40PRG-PP	PrismShield™ Plus 40 Cal/cm <sup>2</sup> Lift Front Hood (premium)
LFH65PRG-PP	PrismShield™ Plus 65 Cal/cm <sup>2</sup> Lift Front Hood (premium)
LFH100PRG-PP	PrismShield™ Plus 100 Cal/cm <sup>2</sup> Lift Front Hood (premium)

\*Premium refers to use of GlenGuard premium, lightweight fabric



**PrismShield™ Plus Lift Front Hood** is a lighter, more comfortable arc flash hood that provides users with clear visibility, breathability, and safety.



## HONEYWELL SALISBURY FACE SHIELD SPECIFICATIONS



FACE SHIELD SPECIFICATIONS					
	PrismShield™ Face Shield	PrismShield™ Plus Face Shield	PrismShield™ Plus Pro-Hood	PrismShield™ Plus Lift Front Hood	Description
Available in Category 2	Yes	Yes	Yes	Yes	-
Available in Category 4	No	No	Yes	Yes	-
Weight balancing	Yes	Yes	No	Yes	Weight balancing frames increase comfort by reducing neck strain for users. The face shield can be centered above the hard hat and feels weightless while in the stowed position.
Lens color	Gray	Bronze tinted	Bronze tinted	Bronze tinted	Bronze tinted lenses have an improved visible light transmittance (VLT) compared to gray lenses. Higher VLT means that more light will go through the lens to help users see better in darker conditions. Using the PrismShield™ Plus provides similar color perception as not wearing a face shield at all.
One-piece double curved design	No	Yes	Yes	Yes	Only Honeywell offers a one-piece face shield lens that offers the user a complete unobstructed view.
Built-in vents	No	Yes	Yes	Yes	Vents allow airflow and usage for longer periods of time. Vents are standard in all PrismShield™ Plus models.  The additional vents in the rear of the Pro-Hoods provide additional fresh air.
Can be used with non North Zone hard hats	No	Yes	No	No	The shield can be ordered in a universal model to fit with hard hats from other manufacturers.
Integrated Pro-Wear Plus™ fabric for neck protection	No	No	Yes	Yes	Integrated fabric provides neck protection which means a balaclava is not needed.
Specialty coating	Anti-fog, anti-scratch	Anti-fog, anti-scratch	Anti-fog, anti-scratch	Anti-fog, anti-scratch	PrismShield Plus lens is 3X more scratch resistant than the PrismShield lens

## ARC FLASH PROTECTIVE GARMENTS

Welcome to a new level of safety, comfort and style: The Honeywell Salisbury Pro-Wear® Plus series of arc flash garments.

With our long-standing expertise in arc flash protection and a deep understanding of worker wants and needs, Honeywell Salisbury has redefined the notion of comfort style and safety. The lightweight design, soft fabrics and optimal fit are truly a difference that you will feel. All this is accompanied by a complete feature set for a professional grade arc flash line up.

Garments are available in calories 8 to 40 in our standard, Westex UltraSoft® fabric. 40 calorie garments are also available in premium, lightweight GlenGuard fabric. 65 and 100 calorie garments are only available in premium material.

### BREAKTHROUGH COMFORT IN OUR LIGHTEST AND MOST BREATHABLE 40 CAL/CM2 PREMIUM GARMENTS

**SOFTER ANTISTATIC FLAME RETARDANT** outer shell

**BREATHABLE ANTISTATIC LIGHTER IN WEIGHT** mid-layers & liner

**500% MORE BREATHABLE\*\***

**43% LIGHTER IN WEIGHT\*\***

**28% SOFTER TO TOUCH\*\*\***

\* Tested at independent lab  
\*\* Compared to 40 Cal/cm<sup>2</sup> standard offering  
\*\*\* Compared to 40 Cal/cm<sup>2</sup> PLT

PRO-WEAR® PLUS				
ATPV Rating	Outer Layer Material	Layers	Fabric Ensemble Weight	
8 Cal/cm <sup>2</sup>	Westex UltraSoft® fabric	1	8.9 oz/yd <sup>2</sup>	301.7 g/m <sup>2</sup>
12 Cal/cm <sup>2</sup>	Westex UltraSoft® fabric	1	10.1 oz/yd <sup>2</sup>	342.4 g/m <sup>2</sup>
20 Cal/cm <sup>2</sup>	Westex UltraSoft® fabric	1	13.1 oz/yd <sup>2</sup>	444.1 g/m <sup>2</sup>
40 Cal/cm <sup>2</sup> (Standard)	Westex UltraSoft® fabric	2	19.8 oz/yd <sup>2</sup>	671.2 g/m <sup>2</sup>
40 Cal/cm <sup>2</sup> (Premium)	Glen Raven GlenGuard® fabric	2	10.9 oz/yd <sup>2</sup>	369.5 g/m <sup>2</sup>
65 Cal/cm <sup>2</sup>	Glen Raven GlenGuard® fabric	3	17.2 oz/yd <sup>2</sup>	583.1 g/m <sup>2</sup>
100 Cal/cm <sup>2</sup>	Glen Raven GlenGuard® fabric	3	22.3 oz/yd <sup>2</sup>	756 g/m <sup>2</sup>

## PRO-WEAR® PLUS INDIVIDUAL GARMENTS

Pro-Wear Plus garments are available in coats, coveralls, bibs, and pants.

### ATPV CLASSES OF PROTECTION AVAILABLE-CAL/CM<sup>2</sup>

Description	8	12	20	40	65	100
Coats	•	•	•	•	•	•
Over Pants	•	•				
Bib Overalls	•	•	•	•	•	•
Coveralls	•	•	•			



ACC12RG



ACC40PRG

### ENHANCED FIT

All garment types have been re-sized (based on ASTM D6240/ D6240M and ASTM D8077/ D8077M) for the best fit, improved comfort and mobility.

### SPORTY LOOK

Modernized appearance and unified look.



## PRO-WEAR® PLUS INDIVIDUAL GARMENTS



ACB40RG



ACB100RG

### BIB OVERALL

SKU	Description
ACB8RG	8 Cal/cm <sup>2</sup> Bib
ACB12RG	12 Cal/cm <sup>2</sup> Bib
ACB20RG	20 Cal/cm <sup>2</sup> Bib
ACB40RG	40 Cal/cm <sup>2</sup> Bib
ACB40PRG	40 Cal/cm <sup>2</sup> Bib (premium)
ACB65PRG	65 Cal/cm <sup>2</sup> Bib (premium)
ACB100RG	100 Cal/cm <sup>2</sup> Bib (premium)

- Adjustable suspenders with soft velour backing
- Elongated gusseted crotch for easier, more natural leg movement
- Reinforced articulated knees for enhanced ergonomic fit and added protection
- Extended waist tabs for easy opening
- 14 inch leg slits for easy donning/ doffing while wearing boots

### COVERALL

SKU	Description
ACCA8RG	8 Cal/cm <sup>2</sup> Coverall
ACCA12RG	12 Cal/cm <sup>2</sup> Coverall
ACCA20RG	20 Cal/cm <sup>2</sup> Coverall

- Shortened collar for comfortable neck movement
- Articulated sleeve for enhanced comfort
- Elasticated back waist
- Elongated gusseted crotch for easier, more natural leg movement
- Reinforced articulated knees for enhanced ergonomic fit and added protection
- 14 inch leg slits for easy donning/ doffing while wearing boots

### COAT

SKU	Description
ACC8RG	8 Cal/cm <sup>2</sup> Coat
ACC12RG	12 Cal/cm <sup>2</sup> Coat
ACC20RG	20 Cal/cm <sup>2</sup> Coat
ACC40RG	40 Cal/cm <sup>2</sup> Coat
ACC40PRG	40 Cal/cm <sup>2</sup> Coat (premium)
ACC65PRG	65 Cal/cm <sup>2</sup> Coat (premium)
ACC100RG	100 Cal/cm <sup>2</sup> Coat (premium)

- Shortened collar for more comfortable neck movement
- Drop tail back allows for increased movement without skin exposure and loss of protection
- Articulated sleeve for enhanced comfort
- Hook and loop closure. Additional non-metal zipper closure on all premium coats

### OVER PANTS

SKU	Description
ACP8RG	8 Cal/cm <sup>2</sup> Over Pants
ACP12RG	12 Cal/cm <sup>2</sup> Over Pants

- Elongated gusseted crotch for easier, more natural leg movement
- Reinforced articulated knees for enhanced ergonomic fit and added protection
- Extended waist tabs for easy opening
- 14 inch leg slits for easy donning/ doffing while wearing boots



## ARC FLASH KITS PPE CAT 2: 8, 12, AND 20 CAL

PPE Category 2 Kits are available in 8, 12 and 20 calorie protection levels. They come in three different clothing configurations: jacket and bib, coverall, and jacket and pants. They also come with three different face shield options: weight balancing face shield, pro-hood, or lift front hood. The below explanations should help you in understanding the available combinations and their SKUs.

8 CAL/CM <sup>2</sup> KITS	
SKU	Description
SK8RG(size)-WB	PrismShield™ 10 Cal/cm <sup>2</sup> weight balancing face shield with hard hat, Pro-Wear® Plus 8 Cal/cm <sup>2</sup> bib overalls and coat, balaclava, face shield bag, and large bag to carry all kit contents.
SKCP8RG(size)-WB	PrismShield™ 10 Cal/cm <sup>2</sup> weight balancing face shield with hard hat, Pro-Wear® Plus 8 Cal/cm <sup>2</sup> coat and pants, balaclava, face shield bag, and large bag to carry all kit contents.
SKCA8RG(size)-WB	PrismShield™ 10 Cal/cm <sup>2</sup> weight balancing face shield with hard hat, Pro-Wear® Plus 8 Cal/cm <sup>2</sup> coverall, balaclava, face shield bag, and large bag to carry all kit contents.
SK8RG(size)-PP	PrismShield™ Plus 8 Cal/cm <sup>2</sup> Pro-Hood, Pro-Wear® Plus 8 Cal/cm <sup>2</sup> bib overalls and coat, hard hat, and large bag to carry all kit contents.



12 CAL/CM <sup>2</sup> KITS	
SKU	Description
SK12RG(size)-PP	PrismShield™ Plus 12 Cal/cm <sup>2</sup> Pro-Hood, Pro-Wear® Plus 12 Cal/cm <sup>2</sup> bib overalls and coat, hard hat, and large bag to carry all kit contents.
SK12RG(size)-LF-PP	PrismShield™ Plus 20 Cal/cm <sup>2</sup> lift front hood, Pro-Wear® Plus 12 Cal/cm <sup>2</sup> bib overalls and coat, face shield bag, and large bag to carry all kit contents.
SKCA12RG(size)-WB-PP	PrismShield™ Plus 12 Cal/cm <sup>2</sup> weight balancing face shield with hard hat, Pro-Wear® Plus 12 Cal/cm <sup>2</sup> coverall, balaclava, face shield bag, and large bag to carry all kit contents.
SKCA12RG(size)-LF-PP	PrismShield™ Plus 20 Cal/cm <sup>2</sup> lift front hood, Pro-Wear® Plus 12 Cal/cm <sup>2</sup> coverall, face shield bag, and large bag to carry all kit contents.
SKCP12RG(size)-WB-PP	PrismShield™ Plus 12 Cal/cm <sup>2</sup> weight balancing face shield with hard hat, Pro-Wear® Plus 12 Cal/cm <sup>2</sup> coat and pants, balaclava, face shield bag, and large bag to carry all kit contents.



20 CAL/CM <sup>2</sup> KITS	
SKU	Description
SK20RG(size)-PP	PrismShield™ Plus 20 Cal/cm <sup>2</sup> Pro-Hood, Pro-Wear® Plus 20 Cal/cm <sup>2</sup> bib overalls and coat, hard hat, and large bag to carry all kit contents.
SK20RG(size)-LF-PP	PrismShield™ Plus 20 Cal/cm <sup>2</sup> lift front hood, Pro-Wear® Plus 20 Cal/cm <sup>2</sup> bib overalls and coat, face shield bag, and large bag to carry all kit contents.
SKCA20RG(size)-WB-PP	PrismShield™ Plus 20 Cal/cm <sup>2</sup> weight balancing face shield with hard hat, Pro-Wear® Plus 20 Cal/cm <sup>2</sup> coverall, balaclava, face shield bag, and large bag to carry all kit contents.
SKCA20RG(size)-LF-PP	PrismShield™ Plus 20 Cal/cm <sup>2</sup> lift front hood, Pro-Wear® Plus 20 Cal/cm <sup>2</sup> coverall, face shield bag, and large bag to carry all kit contents.



## ARC FLASH KITS PPE CAT 4: 40, 65, AND 100 CAL

PPE Category 3 kits are available in 40, 65, and 100 calorie protection levels. They come with bib overalls and a jacket. They also come with 2 different face shield options: pro-hood or lift front hood. The below explanations should help you in understanding the available combinations and their SKUs.

40 CAL/CM <sup>2</sup> KITS	
SKU	Description
SK40RG(size)-PP	PrismShield™ Plus 40 Cal/cm <sup>2</sup> Pro-Hood, Pro-Wear® Plus 40 Cal/cm <sup>2</sup> bib overalls and coat, hard hat, and large bag to carry all kit contents.
SK40PRG(size)-PP	PrismShield™ Plus 40 Cal/cm <sup>2</sup> Pro-Hood (premium), Pro-Wear® Plus 40 Cal/cm <sup>2</sup> bib overalls and coat (premium), hard hat, and large bag to carry all kit contents.
SK40RG(size)-LF-PP	PrismShield™ Plus 40 Cal/cm <sup>2</sup> lift front hood, Pro-Wear® Plus 40 Cal/cm <sup>2</sup> bib overalls and coat, face shield bag, and large bag to carry all kit contents.
SK40PRG(size)-LF-PP	PrismShield™ Plus 40 Cal/cm <sup>2</sup> lift front hood (premium), Pro-Wear® Plus 40 Cal/cm <sup>2</sup> bib overalls and coat (premium), face shield bag, and large bag to carry all kit contents.



65 CAL/CM <sup>2</sup> KITS	
SKU	Description
SK65PRG(size)-PP	PrismShield™ Plus 65 Cal/cm <sup>2</sup> Pro-Hood (premium), Pro-Wear® Plus 65 Cal/cm <sup>2</sup> bib overalls and coat (premium), hard hat, and large bag to carry all kit contents.
SK65PRG(size)-LF-PP	PrismShield™ Plus 65 Cal/cm <sup>2</sup> lift front hood (premium), Pro-Wear® Plus 65 Cal/cm <sup>2</sup> bib overalls and coat (premium), face shield bag, and large bag to carry all kit contents.



100 CAL/CM <sup>2</sup> KITS	
SKU	Description
SK100PRG(size)-PP	PrismShield™ Plus 100 Cal/cm <sup>2</sup> Pro-Hood (premium), Pro-Wear® Plus 100 Cal/cm <sup>2</sup> bib overalls and coat (premium), hard hat, and large bag to carry all kit contents.
SK100PRG(size)-LF-PP	PrismShield™ Plus 100 Cal/cm <sup>2</sup> lift front hood (premium), Pro-Wear® Plus 100 Cal/cm <sup>2</sup> bib overalls and coat (premium), face shield bag, and large bag to carry all kit contents.



## ARC FLASH HEAD AND FACE KITS

HEAD AND FACE PROTECTION KITS	
SKU	Description
SKA10	10 Cal/Cm <sup>2</sup> Safety Kit with PrismShield™ weight balancing face shield with hard hat, balaclava, and face shield bag
SKA12-PP	12 Cal/Cm <sup>2</sup> Safety Kit with PrismShield™ Plus weight balancing face shield with hard hat, balaclava, and face shield bag
SKA20-PP	20 Cal/Cm <sup>2</sup> Safety Kit with PrismShield™ Plus weight balancing face shield with hard hat, balaclava, and face shield bag

## ACCESSORIES, REPLACEMENT, AND SPARE PARTS

### COLD WEATHER INNER LENS

- Cold weather anti-fog insert lens that has an air spaced design to decrease fogging
- Natural convection air flow design also helps minimize fogging
- Shield meets the ASTM requirements for an anti-fog lens
- Works on all -PP models, even full brim and universal

ANTI-FOG INNER LENS	
SKU	Description
AFLENS-PP	Anti-fog insert lens for all Prismshield™ Plus models
AFLENS-ES	Anti-fog insert lens for AS1000-SPL and AS1000U-SPL



AFLENS-PP

### BAGS

BAGS	
SKU	Description (L x W x H)
AS BAG	Face shield storage bag (21 in x 19 in x 14 in)
SK BAGR	Large red storage bag (25 in x 13 in x 13.5 in)
SKBACKPACK	Reinforced specialty backpack (14 in x 8 in x 18 in)



AS BAG



SK BAGR



SKBACKPACK

## FLAME RESISTANT ATTACHABLE TASK LIGHTS

The rated task light features a high intensity long-lasting white LED lamp with an overall brightness of 35 lumens. From a 2 ft distance, the beam is approximately 6 inches to 7 inches in diameter. The high intensity illumination is very useful when working up close. Two AAA batteries provide 14 to 15 hours of high brightness. SKU is FLKIT. Each FLKIT comes with one task light and clip (clip SKU FLCLIP) which fits on the side of any Honeywell Salisbury face shield.



FLKIT



FLCLIP



AS12CLIP



LFH20FSA-PP



AS1200FB-PP



SHRD-40PRG-PP

REPLACEMENT PARTS	
SKU	Description
AS1200-PP	Replacement lens for AS1200HAT-PP
AS1200FB-PP	Replacement lens for AS1200HAT-FB-PP
AS2000-PP	Replacement lens for AS2000HAT-PP
AS2000FB-PP	Replacement lens for AS2000HAT-FB-PP
LFH20FSA-PP	Replacement lens for LFH20RG-PP
LFH40FSA-PP	Replacement lens for LFH40RG-PP, LFH40PRG-PP, LFH25PO-PP
LFH100FSAB-PP	Replacement lens for LFH65PRG-PP and LFH100PRG-PP
1200-PP	Replacement lens for FH8RG-PP, FH12RG-PP
4000-PP	Replacement lens for FH20RG-PP, FH40RG-PP, FH40PRG-PP
10000-PP	Replacement lens for FH65PRG-PP, FH100PRG-PP
SHRD-20RG-PP	Replacement shroud for LFH20RG-PP
SHRD-40RG-PP	Replacement shroud for LFH40RG-PP
SHRD-40PRG-PP	Replacement shroud for LFH40PRG-PP
SHRD-65PRG-PP	Replacement shroud for LFH65PRG-PP
SHRD-100PRG-PP	Replacement shroud for LFH100PRG-PP
AS12CLIP	Replacement clips for hard hat attachment, all face shields models. Comes with 2 clips
RES-U	Replacement strap for PrismShield™ universal face shield models AS1000U-SPL
RES-FB	Replacement strap for PrismShield™ full brim face shield models AS1000FB-SPL
RES-U-PP	Replacement strap for PrismShield™ Plus universal face shield models AS1200U-PP and AS2000U-PP
RES-FB-PP	Replacement strap for PrismShield Plus full brim face shield models: AS1200FB-PP and AS2000FB-PP

## NORTH ZONE HARD HATS

Honeywell Salisbury pairs its face shields with Honeywell North Zone hard hats because they add the perfect combination of comfort, retention, and balance.

NORTH ZONE HARD HATS	
SKU	Description
N10R030000	N10 cap style orange hard hat, ratchet
N20R460000	N20 full brim hi-viz orange hard hat, ratchet
N10RS	Ratchet replacement suspension



N10R030000



N20R460000

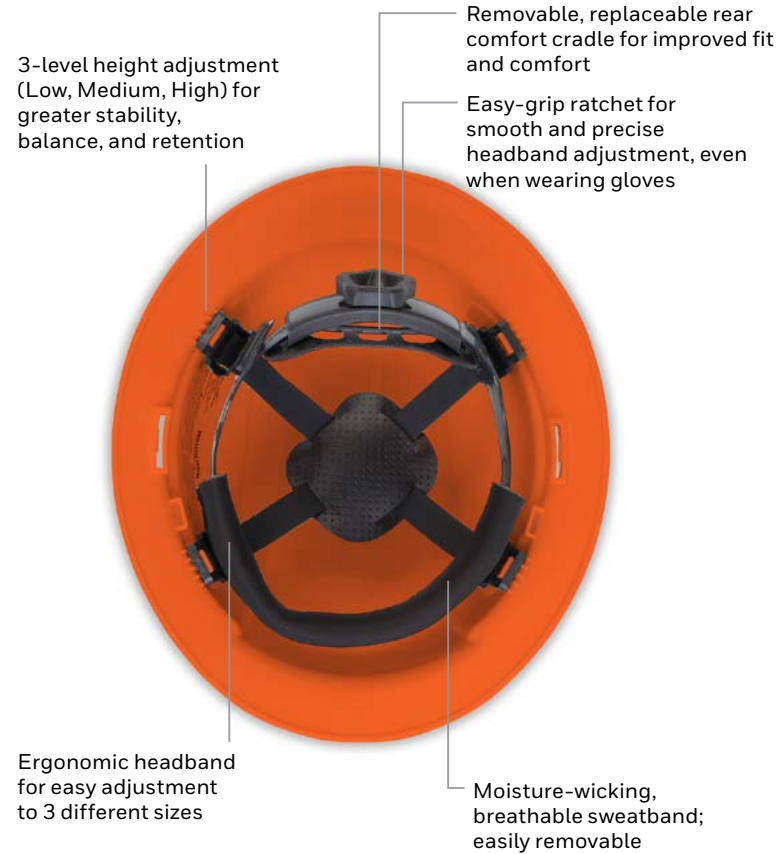

## UNDERSTANDING THE PRODUCT NUMBER

The following examples explain the meaning of each letter in the part number.

### EXAMPLES:

ARC	GARMENT TYPE	ATPV RATING	PREMIUM	COLOR	SIZE
AC	C - Coat CA - Coverall P - Over Pant B - Bib Overall	8 12 20 40 65 100	Premium Fabric Materials	RG: Red and Grey O: Orange	S M L XL 2X 3X 4X 5X

Part number: ACC40PRGS

HOOD TYPE	ATPV RATING	PREMIUM	COLOR	PRISMESHIELD™ PLUS
FH Fixed Hood (Pro-Hood) LFH Lift Front Hood	8 12 20 40 65 100	Premium Fabric Materials	RG: Red and Grey O: Orange	

Part number: FH40PRG-PP

## PRO-WEAR® ARC FLASH GLOVES

Arc Flash gloves help provide hand protection from arc flash events. Gloves are sewn with Nomex® thread and made with arc rated material. Gloves are 14 inches long and designed in a clute cut style. One size fits most.

GLOVES	
SKU	Description
AFG11	12 Cal/cm², navy blue
AFG20	20 Cal/cm², navy blue
AFG40	40 Cal/cm², gray
AFG100	100 Cal/cm², khaki



AFG11



AFG40

Caution: Arc flash gloves do not provide electrical protection. Do not use when insulating, use rubber gloves as required.

SAFETY KIT	OPTIONAL KITS	ATPV RATING	PREMIUM	COLOR	SIZE	OPTIONAL HOODS	PRISMESHIELD™ PLUS
SK	CA - Coverall CP - Over Pant	8 12 20 40 65 100	Premium Fabric Materials	RG: Red and Grey	S M L XL 2X 3X 4X 5X	LF - Lift Front Hood WB - Weight Balancing Face Shield	

Part number: SK40PRGS-LF-PP



## ARC SUPPRESSION BLANKETS

The Arc Suppression Blanket is used as a barrier for protection from the explosive and incendiary effects of electrical arcs and flashes. These hazardous electrical discharges can be caused by faults in cables, in cable splices and joints, and at transformer terminals, or they may be generated by the operation of switch gear, circuit breakers and lightning arrestors, among others. The blanket can be used for worker protection in underground vaults, switchyards, and other locations where electrical equipment poses a risk of exposure to explosive electrical discharges.

### FEATURES & BENEFITS

- Honeywell Salisbury Arc Blankets are available in 4 ft x 5 ft and 4 ft x 8 ft sizes
- Each size is available in 15kA, 25kA or 40kA ratings.
- The 15kA blankets include convenient loops for installation and come in a navy color
- The 25kA and 40kA blankets include grommets to help keep the blanket in place and come in a brown color
- The blankets tie-straps are made up of Kevlar® and come in 48 inch standard length
- Product complies with ASTM F2676

### CHOOSING YOUR ARC SUPPRESSION BLANKET

15 KA BLANKET	
Item #	Description
ARC45-15	4 ft x 5 ft 15 kA blanket
ARC48-15	4 ft x 8 ft 15 kA blanket
ARC48-15PS	4 ft x 8 ft 15 kA blanket kit

25 KA BLANKET	
Item #	Description
ARC45-25	4 ft x 5 ft 25 kA blanket
ARC48-25	4 ft x 8 ft 25 kA blanket
ARC45-25PS	4 ft x 5 ft 25 kA blanket kit
ARC48-25PS	4 ft x 8 ft 25 kA blanket kit

40 KA BLANKET	
Item #	Description
ARC45-40	4 ft x 5 ft 40 kA blanket
ARC48-40	4 ft x 8 ft 40 kA blanket
ARC45-40PS	4 ft x 5 ft 40 kA blanket kit
ARC48-40PS	4 ft x 8 ft 40 kA blanket kit

KEVLAR® STRAPS	
Item #	Description
STRAP148-12	1 in wide x 48 in long Kevlar® straps, 12 Nos. Applicable for all 4 ft x 5 ft size blankets
STRAP148-16	1 in wide x 48 in long Kevlar® straps, 16 Nos. Applicable for all 4 ft x 8 ft size blankets



ARC45-15

### ORDERING INFORMATION

Arc suppression blankets can be ordered separately or as a part of a kit. Kits include blanket, straps, strap carrying bag (AS BAG), and kit carrying bag (SK BAGR).

### ⚠ WARNING

- Because of the unpredictability of electrical arcs, the Arc Suppression Blanket may not totally contain the arc and flashes, but only reduce or limit explosive and incendiary effects.
- Properly used Arc Suppression Blankets can reduce the risk of injury from the blast and heat.
- They do not provide any personal protection for hearing, eyes, smoke inhalation, hazardous gas inhalation, or burns.
- Arc Suppression Blankets are not designed for electrical insulating protection.
- Arc Suppression Blanket are not for electrical insulation.
- Arc Suppression Blankets require proper maintenance, use, inspection, storage and care in accordance with the applicable Honeywell user guide, manual and/or operating instructions. Failure to follow any portion of Honeywell guidance can result in compromised product performance, which could cause serious injury or death.





## INSULATED HAND TOOL MARKINGS

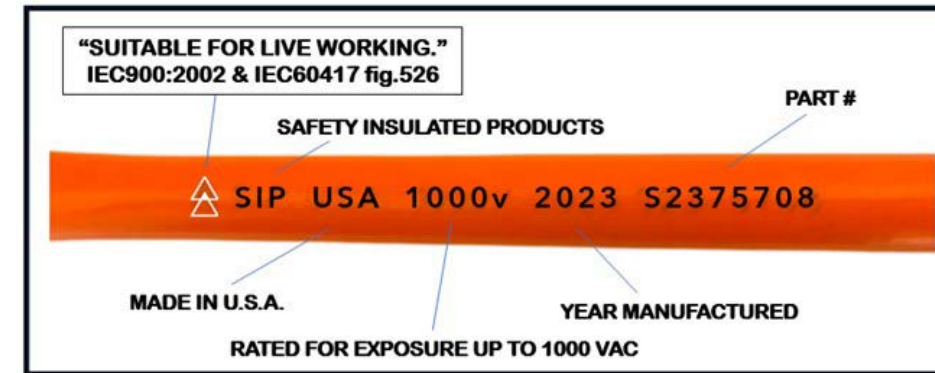

## INSULATED TOOL KITS

### BASIC ELECTRICIAN ROLL

SKU	Description
TK9	9 pc. includes: Slotted screwdrivers: 3/16 in x 4 in, 3/16 in x 6 in, 1/4 in x 4 in Phillips screwdrivers: #1 x 3 in, #2 x 4 in 7 in needle nose pliers 7 in diagonal cutting pliers 9 in lineman pliers Combination stripper / crimper pliers In a tool roll bag



TK9

### DELUX MAINTENANCE TOOL KIT

SKU	Description
TK30	29 pc. includes: Slotted screwdrivers: 1/8 in x 2 in, 3/16 in x 6 in, 1/4 in x 4 in Phillips screwdriver: #1 x 3 in, #2 x 6 in Torque wrench 3/8 in drive 10 in long 30 in/lb to 150 in/lb 3/8 in drive reversible ratchet 3 in and 6 in extensions, 3/8 in drive, 4 nm to 23 nm 8 pc. 3/8 in to 13/16 in deep 12 pt. socket set, 3/8 in drive 8 pc. 3/8 in to 13/16 in box end wrench set 7 in diagonal cutting pliers 8 in needle nose pliers 9 in lineman pliers Mini flashlight In a high impact plastic tool box



TK30

# INSULATED TOOLS

Every insulated hand tool is rated for exposure up to 1000VAC and dielectrically tested at 10,000VAC. These tools meet or exceed current ASTM F1505 and IEC 900 Standards for Insulated Hand Tools. These tools will help you to be compliant with OSHA 29 CFR 1910 Subpart S and NFPA 70E. To fully comply with OSHA 1910.333 (c)(2) and NFPA 70E, insulated hand tools must be used. A complete insulated tool program should be in place to meet these standards. The insulating material used is impact resistant and flame retardant. The two-color insulation makes inspection easier which adds to the overall safety. If the yellow under layer is showing, the tool may no longer be insulated properly and should be considered for electrical retesting.

### ⚠ WARNING

Salisbury insulated tools are to be used as secondary protection and are not intended to be used in place of other personal protective equipment. Whenever possible, always de-energize lines before working on or around them. Although the insulation on Salisbury Tools is impact resistant and flame retardant, each tool should be inspected prior to each use for cracks, cuts, or other damage. Should the yellow insulation become visible through the orange outer layer, discontinue use immediately.

## INSULATED TOOL KITS

### ELECTRICIAN'S TOOL KIT

SKU	Description
TK30ETK	30 pc. includes: 9 in lineman pliers 8 in HD slip joint pliers with cutting shear Crimping tool 9.5 in tongue and groove pliers (water pump) Slotted screwdrivers: 3/16 in x 4 in, 1/4 in x 4 in, 1/4 in x 6 in, 5/16 in x 6 in, 3/8 in x 8 in, 3/16 in x 6 in Phillips screwdrivers: #1 x 3 in, #2 x 4 in Nut drivers: 1/4 in x 3 in, 5/16 in x 3 in, 3/8 in x 3 in, 7/16 in x 3 in, 1/2 in x 3 in, 3/16 in x 3 in, 11/32 in x 3 in 8 in long needle nose pliers with side cutter 7 in box joint cutting pliers 9.5 in cutting pliers 12 in tongue and groove (water pump) 6 in flat nose pliers long arm, type "T" hex wrenches: 3/16 in x 6 in, 1/4 in x 6 in, 5/16 in x 6 in, 3/8 in x 6 in, 7/16 in x 6 in, 1/2 in x 6 in In a high impact plastic tool box



TK30ETK

### HOT BOX TOOL KIT

SKU	Description
TK60	60 pc. includes: Slotted screwdrivers: 1/8 in x 2 in, 3/16 in x 4 in, 3/16 in x 6 in, 1/4 in x 4 in, 5/16 in x 6 in Phillips screwdrivers: #1 x 3 in, #2 x 6 in Nutdrivers: 3/16 in x 3 in, 1/4 in x 3 in, 5/16 in x 3 in, 11/32 in x 3 in, 3/8 in x 3 in, 7/16 in x 3 in, 1/2 in x 3 in Torque wrench 30 in/lb to 150 in/lb; 3/8 in drive reversible ratchet 3 in and 6 in extensions, 3/8 in drive 10 pc. 5/16 in to 7/8 in, 3/8 in drive socket set 11 pc. 3/8 in to 1 in box end wrench set 14 pc. 1/16 in to 1/2 in, 6 in long arm, type "L" in hex wrench set 7 in diagonal cutting pliers 8 in needle nose pliers 9 in lineman pliers 9.5 in cable cutting pliers 9.5 in water pump pliers Combination stripper/crimper pliers In a plastic box including tool rolls



TK60

## INSULATED TOOL KITS

### INSTRUMENT CONTROL KIT

SKU	Description
TK92	Includes: Slotted and Phillips screw starters 3 in shaft nut drivers: 3/16 in, 1/4 in, 5/16 in, 11/32 in, 3/8 in, 7/16 in, 1/2 in, 9/16 in, 5/8 in Phillips screwdrivers #1 x 3 in and #2 x 4 in Slotted screwdrivers: 1/8 in x 2 in, 3/16 in x 6 in, 3/16 in x 10 in, 1/4 in x 4 in, 5/16 in x 6 in, 3/8 in x 8 in Mirror with magnet 2-1/4 in x 3-1/2 in, 6 in OAL with pickup magnet Holding slotted screwdriver 1/8 in x 6 in Holding Phillips screwdriver #2 x 6 in 10 in waterpump pliers 4 electronic pliers long reach, long handle 3 in thin wall nut drivers: 11/32 in and 5/16 in Phillips 90 degree screwdrivers #2 x 6 in and #3 x 6 in Slotted Screwdriver 90 degree 1/4 in x 6 in Mini flashlight Wire stripper long handle Tie wire stripper long handle Crimping tool 9-1/2 in for insulated and non-insulated solderless connectors Folding ruler 6 foot In a backpack designed for tools



TK92

### SECONDARY BUS WORK KIT

SKU	Description
TK93	Includes: 12 in flat pry bar and 12 in 90 degree pry bar 3/8 in x 12 in slotted screwdriver 7 pc 1/2 in drive, 12 point socket set: 3/4 in, 7/8 in, 15/16 in, 1-1/8 in, 1-1/4 in, 1-1/2 in Socket 3/4 in drive 1-3/4 in 12 point Adapter 1/2 in F - 3/4 in M Ratchet 1/2 in drive 5 pc. open end wrench set: 3/4 in, 1-1/8 in, 1-1/4 in, 1-1/2 in, 1-3/4 in Non spark buss line up tool In a backpack designed for tools



TK93

### METER KIT

SKU	Description
TK16MT	Includes: 9 in lineman's pliers 7 in diagonal cutters 8 in long nose pliers Nut drivers: 5/16 in x 3 in, 3/8 in x 3 in, 1/2 in x 3 in Phillips screwdrivers: #1 x 3 in, #2 x 4 in, #3 x 6 in Slotted screwdrivers: 1/8 in x 2 in, 3/16 in x 4 in, 3/16 in x 6 in, 1/4 in x 6 in Fuse puller In a tool box including tool rolls



TK16MT

## WRENCH SETS

### HEX WRENCH "T" HANDLE SET

SKU	Description
S2610M	10 pc. 2 mm to 12 mm 6 in long In a tool roll bag
S262344	11 pc. 5/64 in to 3/8 in 6 in long In a tool roll bag
S2613P	13 pc. 5/64 in to 1/2 in 6 in long In a tool roll bag

### OPEN END WRENCH SET

SKU	Description
S241818	17 pc. includes: 7 mm to 24 mm In a tool roll bag

### BOX END WRENCH SET

SKU	Description
S241818-B	17 pc. includes: 7 mm to 24 mm In a tool roll bag



Hex wrench "T" handle set



S241818



S241818-B

## RATCHET & SOCKET SETS

### DEEP SOCKET 3/8 IN DRIVE SETS

SKU	Description
S103	11 pc. Includes: 3/8 in drive ratchet wrench 3 in and 6 in extensions Deep sockets 12pt: 3/8 in, 7/16 in, 1/2 in, 9/16 in, 5/8 in, 11/16 in, 3/4 in and 13/16 in In a fitted plastic case
S104	16 pc. includes: 3/8 in drive ratchet wrench 3 in and 6 in extensions Deep sockets 12pt: 1/4, 5/16, 3/8, 7/16, 1/2, 9/16, 5/8 in, 11/16 in, 3/4 in, 13/16 in, 7/8 in, 15/16 in and 1 in In a fitted plastic case
S106	Metric 24 pc. includes: 3/8 in drive ratchet wrench 3 in and 6 in extensions Deep sockets 6 pt and 12 pt: 6 mm to 26 mm In a fitted plastic case



S204653

### CLOSE QUARTERS SOCKET SET

SKU	Description
S204653	3/8 in drive 16 pc. includes: 3/8 in drive ratchet wrench 3 in and 6 in extensions Regular sockets 12 pt: 1/4 in, 5/16 in, 3/8 in, 7/16 in, 1/2 in, 9/16 in, 5/8 in, 11/16 in, 3/4 in, 13/16 in, 7/8 in, 15/16 in and 1 in In a tool box

## METRIC INSULATED TOOL KITS

### METRIC DELUXE MAINTENANCE TOOL KIT

SKU	Description
TK30M	29 pc. includes: Slotted screwdrivers: 1/8 in x 2 in, 3/16 in x 6 in, 1/4 in x 4 in Phillips screwdriver: #1 x 3 in, #2 x 6 in Torque wrench 3/8 in drive 10 in long 30 in/lb to 150 in/lb 3/8 in Drive reversible ratchet 3 in and 6 in extensions, 3/8 in drive, 4 nm to 23 nm 8 pc. 12 pt. socket set, 3/8 in drive: 10 mm, 11 mm, 12 mm, 14 mm, 16 mm, 18 mm, 19 mm, 21 mm 8 pc. box end wrench set: 10 mm, 11 mm, 12 mm, 14 mm, 16 mm, 18 mm, 19 mm, 21mm 7 in diagonal cutting pliers 8 in needle nose pliers 9 in lineman Pliers Mini flashlight In a high impact plastic tool box



TK30M

### METRIC HOT BOX TOOL KIT

SKU	Description
TK60M	60 pc. includes: Slotted screwdrivers: 1/8 in x 2 in, 3/16 in x 4 in, 3/16 in x 6 in, 1/4 in x 4 in, 5/16 in x 6 in Phillips screwdrivers: #1 x 3 in, #2 x 6 in 7 pc. 3 in long nut drivers, 5 mm to 12 mm Torque wrench 30 in/lb to 150 in/lb; 4 nm to 23 nm 3/8 in drive reversible ratchet 3 in and 6 in Extensions, 3/8 in drive 10 pc. 8 mm to 22 mm, 3/8 in drive socket set 11 pc. 10 mm to 27 mm box end wrench set 14 pc. 1.5 mm to 12 mm hex wrench set 7 in diagonal cutting pliers 8 in needle nose pliers 9 in lineman pliers 9.5 in cable cutting pliers 9.5 in water pump pliers Combination stripper/crimper pliers In a plastic box, including tool rolls



TK60M

### METRIC ELECTRICIAN'S TOOL KIT

SKU	Description
TK30ETKM	30 pc. includes: 9 in lineman pliers 8 in HD slip joint pliers with cutting shear Crimping tool 9.5 in tongue and groove pliers (water pump) Slotted screwdrivers: 3/16 in x 4 in, 1/4 in x 4 in, 1/4 in x 6 in, 5/16 in x 6 in, 3/8 in x 8 in, 3/16 in x 6 in Phillips screwdrivers: #1 x 3 in, #2 x 4 in Nut drivers: 5mm x 3 in, 6mm x 3 in, 7mm x 3 in, 8mm x 3 in, 9mm x 3 in, 11mm x 3 in, 12mm x 3 in 8 in long needle nose pliers with side cutter 7 in box joint cutting pliers 9.5 in pliers cutting pliers 12 in tong and groove (waterpump) 6 in flat nose pliers Long arm, type "T" hex wrenches: 4 mm x 6 in, 5 mm x 6 in, 6 mm x 6 in, 8 mm x 6 in, 10 mm x 6 in, 12 mm x 6 in In a high impact plastic tool box



TK30ETKM

## NON-SPARKING & NON-MAGNETIC SAFETY TOOL KITS

### NON-SPARKING & NON-MAGNETIC BASIC ELECTRICIAN ROLL

SKU	Description
TK10NS	9 pc. includes: 3/16 in x 4 in slotted screwdriver 1/4 in x 6 in slotted screwdriver 5/16 in x 6 in slotted screwdriver #2 x 4 in Phillips screwdriver #1 x 3 in Phillips screwdriver 7 in needle nose pliers 7.5 in diagonal pliers 8 in lineman pliers 10 water pump pliers In a tool roll bag



TK10NS

### NON-SPARKING & NON-MAGNETIC SCREWDRIVER KIT

SKU	Description
S23873NS	10 pc. includes: 1/8 in x 3 in slotted screwdriver 3/16 in x 4 in slotted screwdriver 1/4 in x 6 in slotted screwdriver 5/16 x 6 in slotted screwdriver 3/8 x 8 slotted screwdriver 3/8 x 12 slotted screwdriver #1 x 3 Phillips screwdriver #2 x 4 Phillips screwdriver #3 x 6 Phillips screwdriver #4 x 8 Phillips screwdriver In a tool roll bag



23873NS

### NON-SPARKING & NON-MAGNETIC SOCKET SET

SKU	Description
S204654NS	3/8 in drive set 15 pc. includes : 3/8 in ratchet 7 in 3 in and 6 in flared extensions Regular sockets 6 pt:1/4 in, 5/16 in, 3/8 in, 7/16 in, 1/2 in, 9/16 in, 5/8 in, 11/16 in, 3/4 in, 13/16 in, 7/8 in, and 15/16 in In a plastic case



S204654NS

## SCREWDRIVER & NUTDRIVER KIT SETS & TOOLS

### NUTDRIVER 6 IN LENGTH SETS WITH CUSHION GRIP

SKU	Description
S25922L	9 pc. includes: 3/16 in, 1/4 in, 5/16, 11/32 in, 3/8 in, 7/16 in, 1/2 in, 9/16 in, 5/8 in In tool roll bag
S25925L	Metric set, 8 pc. includes: 5 mm, 6 mm, 7 mm, 8 mm, 9 mm, 10 mm, 11 mm, 12 mm In tool roll bag



S25922L

### SCREWDRIVER SETS WITH CUSHION GRIP

SKU	Description
S23870	10 pc. includes: #1 x 3 in, #2 x 4 in; #3 x 6 in, 1/8 in x 2 in, 3/16 in x 6 in, 3/16 in x 10 in, 1/4 in x 4 in, 5/16 in x 6 in, 3/8 in x 8 in, 3/8 in x 12 in In tool roll bag



S23870

## INDIVIDUAL TOOLS & ACCESSORIES

### WRENCH

SKU	Description
S2651634	Hex wrench 9/16 in, 6 in long "T" handle, 9/16 in



S2651634

### TORQUE WRENCH

SKU	Description
S22TCI150FRN	Torque wrench 1/2 in drive, 18.5 in long, 10 ft/lb to 150 ft/lb (20 nm to 210 nm)
S22TCI150RA38	Torque wrench 3/8 in drive, 10 in long, 30 in/lb to 200 in/lb (4 nm to 23 nm)
S22TCI75FRN	Torque wrench 3/8 in drive, 14.5 in long, 5 ft/lb to 75 ft/lb (5 nm to 105 nm)



Torque wrench

### SLOTTED AND PHILLIPS SCREWDRIVERS

SKU	Description
S2375704	Slotted screwdriver 1/4 in x 4 in
S2375705	Slotted screwdriver 1/4 in x 6 in
S2375904	Slotted screwdriver 3/16 in x 4 in
S2375906	Slotted screwdriver 3/16 in x 6 in
S2375706	Slotted screwdriver 5/16 x 6 in
S2375710	Slotted screwdriver 3/8 x 10 in
S2376103	Phillips screwdriver #1 x 3 in
S2376104	Phillips screwdriver #2 x 4 in
S2376106	Phillips screwdriver #3 x 6 in



Slotted screwdriver



Phillips screwdriver

## ELECTRIC VEHICLE TOOL KITS

COMMERCIAL AND CONSUMER ELECTRIC VEHICLE KIT	
SKU	Description
TK84	Sockets: 8 mm 3/8 in drive 6 pt, 12 mm 3/8 in drive 6 pt, 14 mm 3/8 in drive 6 pt Extensions 3/8 in drive: 3 in, 6 in, and 12 in Screwdrivers: Phillips #1 x 3 in, #1 x 6 in, #2 x 4 in, #2 x 8 in Plier long needle nose 7 in Socket 10 mm, 3/8 in drive 6 pt Reversible ratchet wrench 3/8 in drive 3/8 in drive 50 in/lb to 250 in/lb torque wrench Shaft nut driver 10 mm x 6 in 5-3/4 in OAL tweezer 12 in double ended pickup magnet 5 lb to 1-1/2 lb pulling capacity 3/8 in female to 1/4 in male long adapter Extensions 6 in, 1/4 in drive TORX bit socket T30 long 1/4 in drive 10 mm deep socket 6 in t-socket driver, 3/8 in 3/8 in drive 8 mm deep socket 3/8 in drive 10 mm deep socket 3/8 in drive 12 mm deep socket 3/8 in drive 14 mm deep socket In a tool box including tool rolls



TK84

ELECTRIC VEHICLE MASTER SHOP KIT	
SKU	Description
EV124	Ratchet and socket set metric 14 pc. Open end wrench set 13 pc. 7 mm to 19 mm Screwdriver set 8 pc. Nut driver 6 in metric set 8 pc. Plier long needle nose 8 in Plier linesman 8 in Screwdriver TORX T25 x 3 in Screwdriver TORX T30 x 4 in Plier long reach 7 1/2 in Plier linesman 9 in "T" wrench for sockets 6 in, 3/8 in drive TORX bit socket T20, 1/4 in TORX bit socket T25, 1/4 in TORX bit socket T30, 1/4 in Torque Wrench 3/8 in drive 14 1/4 in long 15 ft/lb to 75 ft/lb Adapter 3/8 in female to 1/4 in male Torque wrench 3/8 in drive 30 in/lb to 150 in/lb 12 in double ended pickup magnet In a tool box including tool rolls



EV124

## TOOLS & ACCESSORIES

PLIERS	
SKU	Description
S21440	Tongue and groove pliers 12 in, 2-1/4 in capacity
S21422	V groove pliers 9-1/2 in, 1-1/2 in capacity
S21442	V groove pliers 12 in, 2-1/4 in capacity



V groove pliers

CABLE STRIPPER	
SKU	Description
S21368CKINS	Cable stripping tool



S21368CKINS

DEEP SOCKET	
SKU	Description
S2040824	Deep socket 3/4 in, 1/2 in drive



S2040824

SCREW STARTERS	
SKU	Description
ULL-N-4	Slotted screw starter
ULL-PN-12	Phillips screw starter



ULL-N-4



ULL-PN-12

EXTENSIONS	
SKU	Description
S2045161	3/8 in drive extension 6 in



S2045161

NON-SPARKING ALIGNMENT TOOL	
SKU	Description
S3042916-2NS	Non-sparking alignment tool 13-1/2 in OAL



S3042916-2NS

### INSULATED TOOL MAINTENANCE

Because moisture, films or other surface contaminants are conductive, insulated tools must be kept clean dry and free of any surface contaminants. Insulated tools can be cleaned using the same specialty concentrated detergent used to remove oils, grease, and dirt from rubber insulated gloves. Ensure the cleaning agent does not contain any chemicals which may harm or lessen the protective properties of the insulating coating.

Avoid storing insulated tools in proximity to sources of heat such as radiators, furnaces, and steam pipes.

For replacement tools that Honeywell Salisbury does not carry, refer to website of our insulated tool supplier: [www.1000vtools.com](http://www.1000vtools.com)



# DIELECTRIC FOOTWEAR

Navigating the realm of electricity, particularly in wet or damp environments, presents inherent hazards. Individuals undertaking such tasks require specialized insulating footwear to safeguard against electric shock within medium to high voltage settings. It's crucial to recognize that even after equipment shutdown, there remains a potential risk stemming from residual charges. Additionally, even when a worker is at a considerable distance from an electrical site, the threat of shock persists due to step potential. The use of dielectric footwear becomes paramount, offering electrical insulation that effectively mitigates the risk of electric shock. It is imperative for such footwear to adhere to the standards outlined in ASTM F1117 and F1116 for comprehensive safety compliance.

RELEVANT ASTM STANDARDS	
Standards	Description
ASTM F1116	This test method covers testing to determine the "Dielectric Strength" of dielectric overfoot and overshoe footwear. Testing is done over the maximum possible area of the dielectric footwear without permitting flashover between electrodes.
ASTM F1117	This specification covers acceptance testing of dielectric overfoot and overshoe footwear designed to provide additional isolation or insulation of workers if in accidental contact with energized electrical conductors, apparatus, or circuits.

All Salisbury dielectric footwear is tested to 20 kV (except if otherwise noted) and endures a 3 minute wet test to ensure the entire shoe passes the voltage requirement. Each shoe is marked clearly and permanently with the standard, size and ac voltage rating.

## FAQ

- Q:** What are the benefits of dielectric footwear?  
**A:** Protects ground workers from step and touch potential in the whole work zone, not just one confined work area, like a grounding mat.
- Q:** What is touch potential?  
**A:** Voltage difference between any energized object and the feet of the worker who may be in contact with it. If you touch an energized unit, your body will become the path for the current to flow to the ground. Examples of this danger include downed power lines.

- Q:** What is step potential?  
**A:** Voltage difference between each foot of a person near an energized, grounded unit. Voltage is highest at the source and fades as the energy moves across the ground depending on the resistance of the soil. Lightning, induced voltage, downed wires, metal and wood fences, wet soil, puddles, trees and utility poles can all create zones of high voltage.

## ELECTRIGRIP BOOTS

For users who depend on a single, comfortable boot to provide primary protection from the risk of electric shock. Electrigrip boots were designed around the Honeywell Muck® boots. They feature a proven fit with a locking ankle to prevent heel slip and an outsole design that diverts liquid away to provide better traction and increased stability on slippery surfaces. They are arc flash tested to 40 Cal/cm<sup>2</sup> (per ASTM F2621) and available with quick drying thermal lining to keep feet warm and dry in working conditions.

Electrigrip™ dielectric boots have also been tested and certified compliant to ASTM 2413, and by UL to the CSA Z195 standard.

- PULL-ON HANDLES** for quick donning.
- HIGH-VIS COLOR** for quick recognition and added visibility.
- HAND LAYERED PREMIUM VULCANIZED RUBBER**
- BUILT-IN COMPOSITE SAFETY TOE CAP**
- PUNCTURE RESISTANT SOLE** reduces the possibility of damage or injury from nails, sharp metal, or other objects that could penetrate the sole.
- SIZES:**
  - 15 inch height
  - Whole sizes, 5-16
- 100% WATERPROOF**
- REFLECTIVE STRIPE** provides enhanced visibility for added user safety.
- HEEL KICK-OFF LEDGE** for easy removal.
- RAISED HEEL** with ladder grips for additional traction and stability.
- INTEGRATED SHANK** Wide supportive fiberglass shank distributes body weight evenly and reduces stress on back, legs, and feet.
- QUICK DRYING STYRENE-BUTADIENE RUBBER FOAM** lining that is lightweight and helps feet stay dry and healthy.
- EXCEPTIONAL OUTSOLE TRACTION** designed to shed mud and debris and prevent slips and falls on uneven ground, loose sand and dirt, wet grass, and slick mud.



## ELECTRIGRIP THERMAL DIELECTRIC BOOTS

- Flexible rubber outsole combined with omni-directional hexagons that provide an aggressive grip in slick areas for superb traction on wet or icy metal surfaces
- Thicker quick drying 5 mm SBR lightweight foam lining to keep feet warm and protected in cold and wet conditions

### ELECTRIGRIP BOOTS SPECIFICATIONS

Item #	Description	Size	Upper/Outsole Material	Lining Material	Height	Color
52000 (size) -ES	Electrigrip boot	5-16	Vulcanized Rubber	3 mm SBR foam	15 in (381 mm)	Red / Black
52001 (size) -ES	Electrigrip thermal boot	5-16	Vulcanized Rubber	5 mm SBR foam	15 in (381 mm)	Red / Black

### ELECTRIGRIP SIZING CHART

US Size	Length in (mm)	Width in (mm)
5	9.5 in (241.2 mm)	3.2 in (82.5 mm)
6	9.8 in (249.6 mm)	3.3 in (84.6 mm)
7	10.2 in (258.1 mm)	3.4 in (86.8 mm)
8	10.5 in (266.5 mm)	3.5 in (88.9 mm)
9	10.8 in (275 mm)	3.6 in (91 mm)
10	11.2 in (283.5 mm)	3.7 in (93.1 mm)
11	11.5 in (291.9 mm)	3.7 in (95.2 mm)
12	11.8 in (300.4 mm)	3.8 in (97.4 mm)
13	12.2 in (308.8 mm)	3.9 in (99.5 mm)
14	12.4 in (316 mm)	4 in (101.6 mm)
15	12.8 in (324.8 mm)	4.1 in (103.7 mm)
16	13.1 in (333.2 mm)	4.2 in (105.8 mm)



### REPLACEABLE INSOLES

With arch support to help reduce fatigue and a shock absorbing heel pad, the replaceable insoles provide both cushioning and stability. With engineered high heat and cold resistance, users will appreciate the comfort provided in the toughest weather conditions.

Replaceable insoles can be ordered with sku 51900 (Size)-ES.

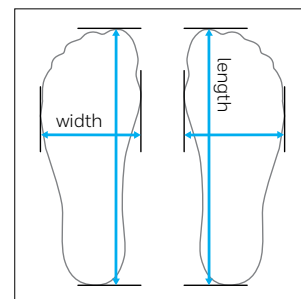
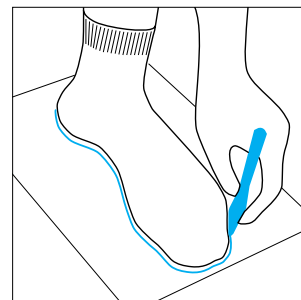

### MEASURING INSTRUCTIONS

#### Step 1.

Put on the socks that will be worn with your Electrigrip boots. It is recommended that measurements be taken at the end of the day when the foot is at its widest point.

#### Step 2:

Trace an outline of each foot onto a sheet of paper. Do not angle the writing instrument, as that may alter the measurement.

#### Step 3.

Measure the longest and widest parts of each foot outline.

#### Step 4:

Using the sizing chart, select the size that is the closest size above your largest foot measurement.

## ELECTRIGUARD OVERBOOTS

Honeywell Salisbury redesigned our classic dielectric over boots – the same proven protection you expect from Salisbury, now with ergonomic innovations and an improved design. Overboots are available in 14 inch (Model# 21406WT) and 17 inch versions (Model# 21405WT).

### EASY ON

wider upper boot with integral pull up handles intended to facilitate donning over standard work boots

### BETTER COMFORT

The wider opening and nylon lining also enables accurate sizing and a more comfortable fit

### COLOR IDENTIFICATION

New color style denoting ASTM F1117 20 kV dielectric performance

### GREATER VISIBILITY

Reflective stripe for enhanced visibility

### EASY OFF

Rear kick-off lugs help wearers easily remove overboots

### OUTSOLE

Vulcanized rubber with a nonskid bar-tread sole

17 in (431.8 mm) option



14 in (355.6 mm) option



### ELECTRIGUARD BOOTS SPECIFICATIONS

Item #	Description	Size	Upper/Outsole Material	Lining Material	Height	Color
21406WT (size)-ES	Electriguard boot	7-17	Vulcanized Rubber	50 % cotton 50 % polyester	14 in. (355.6 mm)	Red / Black
21405WT (size)-ES	Electriguard boot	7-17	Vulcanized Rubber	50 % cotton 50 % polyester	17 in. (431.8 mm)	Red / Black



## DEEP HEEL OVERSHOES

The deep heel overshoes provide extra safety when climbing ladders and poles where the deep heel cavity can lock onto the rungs. All are waterproof and made from premium grade, ozone resistant rubber. The construction is hand-layered in full-cut patterns to fit over work boots. The fabric lining makes them easy to get on and off.

The overshoes come in 4 styles all with pole-climbing reinforcement patch. Styles come with or without buckles, and with or without a bob sole. The 51508 and 51509 soles have a durable construction with a non-skid, bar tread outsole. The 51511 and 51512 have a bob sole with aggressive tread for better traction.

The improved overshoes include a bob sole with aggressive tread for better traction. The deep heel and improved arch are specially designed for climbing ladders comfortably. The wider opening allows for easier on/off.

DIELECTRIC FOOTWEAR SPECIFICATIONS			
Item #	Description	Size	Weight
51508 (size)-ES	Non-buckle overshoe	whole sizes 7-17	3.3 lbs 1.5 (kg)
51509 (size)-ES	2 buckle overshoe	whole sizes 7-17	4.4 lbs (2 kg)
51511 (size)-ES	Bob - sole non-buckle overshoe	whole and half sizes 7-16	3.3 lbs (1.5 kg)
51512 (size)-ES	Bob - 2 buckle overshoe	whole and half sizes 7-16	4.4 lbs (2 kg)

Note: When ordering, add size as suffix to part number. Be sure to add a space between the part number and size. Example: 51511 7-ES



## 15 KV OVERBOOTS

Rated at 15 kV, these 16 inch dielectric overboots were designed with a wider neck opening for easy donning and doffing. This model also contains convenient handles for carrying and pulling the overboot over their daily work boot with ease. Available in size 5-17. SKU 21455WT (size)-ES.

For sizing of all overshoes and overboots, choose one size up from size of work boot. If work boot has steel toe, choose two sizes up.



## DIELECTRIC FOOTWEAR USER INFORMATION

### INSPECTION

In accordance with safe work practices, insulating footwear should be inspected for damage before use each day. Below are examples of what to look for during inspection:

- Any holes, tears, punctures, embedded objects or cuts on the footwear. Users should examine the outside, inside and the sole of the footwear.
- Any changes in texture, such as inelasticity, swelling, softening or hardening.
- If overshoe has buckles and the buckles are broken, the product is considered compromised if the broken buckles are affecting the user from properly wearing the overshoes.

Footwear with contaminants should be cleaned before use. If the contaminants cannot be removed, then the footwear shall not be used.

If the insulating properties of the footwear are suspected, they shall be removed from service. They shall not be reissued for use until they have been retested at an electrical testing facility.

### CARE AND MAINTENANCE

Use household soap or laundry detergent and warm water to clean the footwear, rinse thoroughly and dry.

Do not use cleaners that contain petroleum products. If the lining of the footwear is wet, it should be allowed to dry completely before the next use.

Below are the recommended storage guidelines:

- Store in a cool, dry location.
- The location shall be free from chemicals, oils, solvents, heaters, steam pipes and sunlight
- Footwear should be stored in the natural shape and not be folded, creased, inside out, or compressed.
- Footwear should not be stored when wet or dirty.

It is preferable to store footwear inside bags, boxes or containers that are waterproof and puncture resistant, retested at an electrical testing facility.

**⚠ CAUTION:** Dielectric Footwear should

only be used by Qualified Employees: as defined in OSHA 1910.269; trained in and familiar with the safety related work practices, safety procedures and other safety requirements associated with the use of this type of equipment.



# GROUNDING COMPONENTS

In industrial grounding, electrical workers doing their job on de-energized equipment are exposed to arc flash events of terrible magnitude. Having high-quality grounding equipment is crucial for protecting workers from electric shocks and equipment from being damaged.

Therefore, Honeywell has engineered most innovative grounding devices, offering high-level security, lightweight, flexibility, ease-of use and durability.

Choose the equipment that best suits your needs, from grounding assemblies, sets, clamps to adaptors, connectors and clusters.

## DUCK BILL GROUNDING CLAMPS

0.96 IN (24.4 MM), 1.1 IN (27.9 MM), 1.5 IN (38.1 MM), AND 1.66 IN (42 MM) SIZES

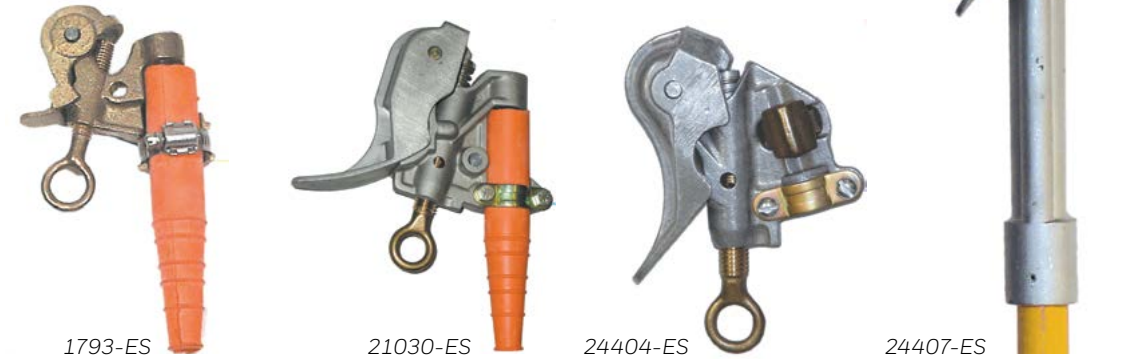

0.96 IN (24.4 MM) DUCKBILL CLAMPS										
Item #	Size in (mm)	Material	ASTM Grade/Class	Thread Type	Eye Screw/T Handle	Strain Relief?	Jaw Type	Main Line Range	Continuous Current (amps) 60 Hz	Weight ea. lb (kg)
1793-ES	0.96 in (24.4 mm)	Bronze	4 / A	V thread	Eye screw	Y	Smooth	556 MCM ACSR to #6	350 RMS amps, 60 Hz	1.3 lb (0.6 kg)
21080-ES	0.96 in (24.4 mm)	Bronze	4 / A	V thread	Eye screw	Y	Smooth	0.96 in to 0.16 in (24.4 mm to 4.1 mm) dia.	350 RMS amps, 60 Hz	1.1 lb (0.5 kg)
1.1 IN (27.9 MM) DUCKBILL CLAMPS										
21030-ES	1.1 in (27.9 mm)	Aluminum	5 / A	V thread	Eye screw	N	Smooth	759 MCM ACSR to #6	400 RMS amps, 60 Hz	1 lb (0.5 kg)
24404-ES	1.1 in (27.9 mm)	Aluminum	5 / A	V thread	Eye screw	N	Smooth	1.1 in to 0.16 in (28.7 mm to 4 mm) dia.	400 RMS amps, 60 Hz	1.5 lb (0.68 kg)
24407-ES	1.1 in (27.9 mm)	Aluminum	5 / A	V thread	Mounted	N	Smooth	400 RMS amps, 60 Hz	400 RMS amps, 60 Hz	4.5 lb (2 kg)
24640-ES	1.1 in (27.9 mm)	Aluminum	5H	V thread	Eye screw	Y	Smooth	900 MCM ACSR to #6 1.16 in to 0.16 in (29.5 mm to 4 mm) dia.	400 RMS amps, 60 Hz	1.55 lb (0.7 kg)
1.5 IN (38.1 MM) DUCKBILL CLAMPS										
24610-ES	1.5 in (38.1 mm)	Aluminum	5H	V thread	Eye screw	Y	Serrated upper, smooth lower	1590 MCM ACSR to #6 1.54 in to 0.16 in (39.1 mm to 4 mm) dia.	400 RMS amps, 60 Hz	1.81 lb (0.82 kg)
1.66 IN (42 MM) DUCKBILL CLAMPS										
2553-ES	1.66 in (42 mm)	Aluminum	5 / B	V thread	Eye screw	N	Serrated	1590 MCM ACSR to #6 1.66 in to 0.16 in (42 mm to 4 mm) dia.	400 RMS amps, 60 Hz	1.4 lb (0.6 kg)

## "C" TYPE GROUNDING CLAMPS

0.83 IN (21.1 MM) AND 1.12 IN (28.4 MM) SIZES

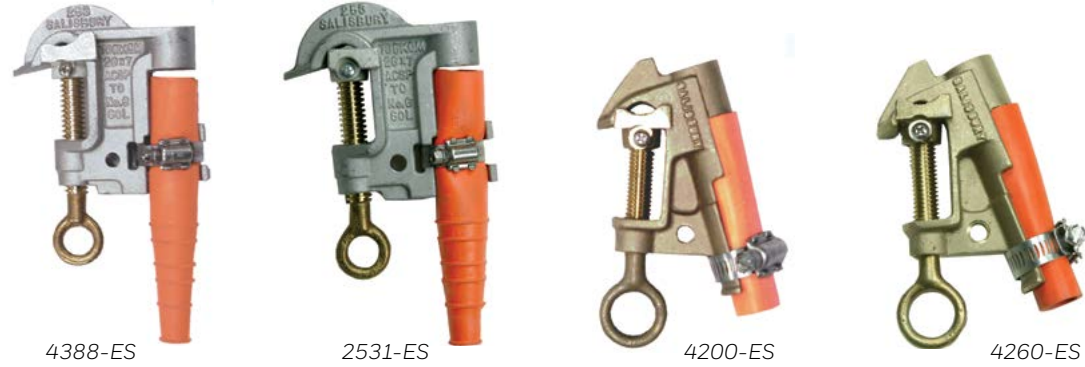

0.83 IN (21 MM) C-CLAMPS										
Item #	Size in (m)	Material	ASTM Grade/Class	Thread Type	Eye Screw/T-Handle	Strain Relief?	Jaw Type	Main Line Range	Continuous Current (amps) 60 Hz	Weight ea. lb (kg)
4200-ES	0.83 in (21.1 mm)	Bronze	5 / A	V Thread	Eye screw	Y	Smooth	477 MCM 18 x 1 ACSR to #8 0.83 in to 0.12 in (21 mm to 3 mm) dia.	400 RMS amps, 60 Hz	1.1 lb (0.5 kg)
21067-ES	0.83 in (21.1 mm)	Bronze	5 / A		Eye screw	Y	Smooth			1 lb (0.4 kg)
4260-ES	0.83 in (21.1 mm)	Bronze	5 / B	V Thread	Eye screw	Y	Smooth upper, serrated curved lower			1.1 lb (0.5 kg)

1.12 IN (28.4 MM) C-CLAMPS										
Item #	Size in (m)	Material	ASTM Grade/Class	Thread Type	Eye Screw/T-Handle	Strain Relief?	Jaw Type	Main Line Range	Continuous Current (amps) 60 Hz	Weight ea. lb (kg)
2531-ES	1.12 in (20.9 mm)	Aluminum	5 / A	Acme	Eye screw	Y	Smooth upper, flat lower	795 MCM 26 in x 7 in (660 mm x 178 mm) ACSR to #8 1.12 in to 0.12 in (29 mm to 3 mm) dia.	400 RMS amps, 60 Hz	1.1 lb (0.5 kg)
4388-ES	1.12 in (20.9 mm)	Aluminum	5 / B	Acme	Eye screw	Y	Smooth upper, curved lower			1.5 lb (0.7 kg)
4389-ES	1.12 in (20.9 mm)	Aluminum	5 / B	Acme	Eye screw	N	Smooth upper, curved lower			1.1 lb (0.5 kg)
9985-ES	1.12 in (20.9 mm)	Bronze	5 / A	Acme	Eye Screw	Y	Smooth upper, curved lower			1.9 lb (0.9 kg)

## "C" TYPE GROUNDING CLAMPS

1.12 IN (28.4 MM)



1.12 IN (28.4 MM) C-CLAMPS										
Item #	Size in (mm)	Material	ASTM Grade/Class	Thread Type	Eye Screw/T-Handle	Strain Relief?	Jaw Type	Main Line Range	Continuous Current (amps) 60 Hz	Weight ea. lb (kg)
2937-ES	1.12 in (20.9 mm)	Bronze	5 / A	Acme	Eye screw	N	Smooth	795 MCM 26 in x 7 in (660 mm x 178 mm) ACSR to #8 1.12 in to 0.12 in (29 mm to 3 mm) dia.	400 RMS amps, 60 Hz	1.8 lb (0.8 kg)
4187-ES	1.12 in (20.9 mm)	Bronze	5 / A	Acme	Eye screw	Y	Serrated			1.9 lb (0.9 kg)
4242-ES	1.12 in (20.9 mm)	Bronze	5 / B	Acme Thread	T-handle	Y	Smooth			1.9 lb (0.9 kg)
9993-ES	1.12 in (20.9 mm)	Aluminum	5 / A	Acme Thread	T-handle	Y	Smooth			1.9 lb (0.9 kg)

## "C" TYPE GROUNDING CLAMPS

1.25 (31.75 MM)



9984-ES



24410-ES



21070-ES

1.25 IN (31.75 MM) C-CLAMPS										
Item #	Size in (mm)	Material	ASTM Grade/Class	Thread Type	Eye Screw/T-Handle	Strain Relief?	Jaw Type	Main Line Range	Continuous Current (amps) 60 hz	Weight ea. lb (kg)
9984-ES	1.25 in (31.75 mm)	Bronze	5 / A	Acme	Eye screw	Y	Smooth upper, flat lower	1035.5 MCM ACSR to #6 1.25 in to 0.16 in (32 mm to 4 mm) dia.	400 RMS amps, 60 Hz	2.2 lb (1 kg)
4255-ES	1.25 in (31.75 mm)	Bronze	5 / A	Acme	Eye screw	Y	Smooth upper, curved lower			2.2 lb (1 kg)
24410-ES	1.25 in (31.75 mm)	Aluminum	5 / A	Acme	Eye screw	Y	Smooth upper, flat lower	1035.5 MCM ACSR to #6 1.25 in to 0.16 in (32 mm to 4 mm) dia.	400 RMS amps, 60 Hz	2.2 lb (1 kg)
24466-ES	1.25 in (31.75 mm)	Aluminum	5 / B	Acme	Eye screw	N	Smooth			2.2 lb (1 kg)
4279-ES	1.25 in (31.75 mm)	Bronze	5 / B	Acme	Eye screw	Y	Serrated upper, curved lower	1035.5 MCM ACSR to #6 1.25 in to 0.16 in (32 mm to 4 mm) dia.	400 RMS amps, 60 Hz	2.2 lb (1 kg)
21070-ES	1.25 in (31.75 mm)	Bronze	5 / B	Acme	Eye screw	N	Serrated upper, flat lower			2.1 lb (0.9 kg)

## "C" TYPE GROUNDING CLAMPS

1.5 IN (38 MM)



1895-ES



2607-ES

1.5 IN (38 MM) C-CLAMPS										
Item #	Size in (mm)	Material	ASTM Grade/Class	Thread Type	Eye Screw/T-Handle	Strain Relief?	Jaw Type	Main Line Range	Continuous Current (amps) 60 hz	Weight ea. lb (kg)
1895-ES	1.5 in (38mm)	Aluminum	5 / B	Acme	Eye screw	Y	Serrated upper, flat lower	1431 MCM ACSR to #6 1.5 in to 0.16 in (38 mm to 4 mm) dia.	400 RMS amps, 60 Hz	1.7 lb (0.8 kg)
2195-ES	1.5 in (38mm)	Aluminum	5 / B	Acme	Eye screw	N	Serrated upper, flat lower			1.5 lb (0.7 kg)
2607-ES	1.5 in (38mm)	Aluminum	5 / B	Acme	Eye screw	Y	Pointed lower, serrated lower			1.7 lb (0.8 kg)

## "C" TYPE GROUNDING CLAMPS

2 IN (51 MM)



21074-ES



20882-ES

2 IN (51 MM) C-CLAMPS										
Item #	Size in (mm)	Material	ASTM Grade/Class	Thread Type	Eye Screw/T-Handle	Strain Relief?	Jaw Type	Main Line Range	Continuous Current (amps) 60 hz	Weight ea. lb (kg)
21074-ES	2 in (51 mm)	Aluminum	5H / A	Acme	Eye screw	Y	Smooth upper, curved lower	3000 MCM ACSR to #6 0.2 in to 0.16 in (51 mm to 4 mm) dia.	400 RMS amps, 60 Hz	2.10 lb (1 kg)
21075-L-ES	2 in (51 mm)	Aluminum	5H / A	Acme	Eye screw	N	Smooth upper, curved lower			2 lb (0.90 kg)
21075-ES	2 in (51 mm)	Aluminum	5H / A	Acme	Eye screw	N	Smooth upper, curved lower			2 lb (0.90 kg)
20882-ES	2 in (51 mm)	Aluminum	5H / B	Acme	Eye screw	Y	Serrated upper, curved lower			2.10 lb (1 kg)
21077-ES	2 in (51 mm)	Aluminum	5H / B	Acme	Eye screw	N	Serrated upper, curved lower			2 lb (0.90 kg)
21942-ES	2 in (51 mm)	Aluminum	5 / B	Acme	Eye screw	N	Serrated upper, flat lower			1035.5 MCM ACSR to #6 2 in to 0.16 in (32 mm to 4 mm) dia.

## "C" TYPE GROUNDING CLAMPS

2.4 IN (60.96 MM)



1923-ES



4377-ES



1921-ES



4295-ES

2.4 IN (60.96 MM) C-CLAMP										
Item #	Size in (mm)	Material	ASTM Grade/Class	Thread Type	Eye Screw/T-Handle	Strain Relief?	Jaw Type	Main Line Range	Continuous Current (amps) 60 hz	Weight ea. lb (kg)
4377-ES	2.4 in (60.96 mm)	Aluminum	5 / A	Acme	Oval eye screw	Y	Smooth upper, flat lower	2 in (51 mm) I.P.S. to #6 2 in to 0.16 in (51 mm to 4 mm)	400 RMS amps, 60 Hz	2.9 lb (1.3 kg)
1924-ES	2.4 in (60.96 mm)	Aluminum	5 / A	Acme	6 ft mounted	Y	Smooth upper, flat lower			5.1 lb (2.3 kg)
4240-ES	2.4 in (60.96 mm)	Aluminum	5 / A	Acme	Eye screw	N	Smooth upper, flat lower			2 in (51mm) I.P.S. to #6 2.4 in to 0.16 in (61 mm to 4 mm) dia.
1923-ES	2.4 in (60.96 mm)	Aluminum	5 / A	Acme	Eye screw	Y	Smooth upper, flat lower	2 in (51 mm) I.P.S. to #6 2 in to 0.16 in (51 mm to 4 mm)	400 RMS amps, 60 Hz	2.1 lb (1kg)
1921-ES	2.4 in (60.96 mm)	Aluminum	5 / B	Acme	Eye screw	Y	Serrated upper, flat lower			2.2 lb (1 kg)
22680-ES	2.4 in (60.96 mm)	Aluminum	5 / A	Acme	Eye screw	Y	Smooth upper, flat lower	2 in (51 mm) I.P.S. to #6 2 in to 0.16 in (51 mm to 4 mm)	400 RMS amps, 60 Hz	4.1 lb (1.9 kg)
4295-ES	2.4 in (60.96 mm)	Bronze	5H / A	Acme	Eye screw	Y	Smooth upper, flat lower			

## "C" TYPE GROUNDING CLAMPS

### 3.5 IN (89 MM)



4282-ES



4341-ES

3.5 IN (89 MM) C-CLAMP										
Item #	Size	Material	ASTM Grade/Class	Thread Type	Eye Screw/T-Handle	Strain Relief?	Jaw Type	Main Line Range	Continuous Current (amps) 60 Hz	Weight ea. lb (kg)
4282-ES	3.5 in (89 mm)	Aluminum	5/A	Acme		Y	Smooth upper, flat lower	3 in to 1.5 in (76.2 mm to 38 mm)	400 RMS amps, 60 Hz 400 RMS amps, 60 Hz	2.8 lb (1.3 kg)
4283-ES	3.5 in (89 mm)				Mounted	Y	Smooth jaw, flat upper	1.P.S. 3.5 in to 1.75 in (89 mm to 44 mm) dia.		5.8 lb (2.5 kg)
4341-ES	3.5 in (89 mm)	Aluminum	5 / A	Acme	Long eye screw	Y	Smooth upper, flat serrated lower	2 in (51 mm) I.P.S. to #6		2.9 lb (1.3 kg)
21953-ES	3.5 in (89 mm)	Aluminum	5H / A	Acme	Eye screw	Y	Smooth upper, flat lower	2 in to 0.16 in (51 mm to 4 mm)		3.8 lb (1.7 kg)
21985-ES	3.5 in (89 mm)	Aluminum	6 / B	Acme	Long eye screw	Y	Serrated upper, flat lower			3 lb (1.5 kg)

## "C" TYPE GROUNDING CLAMPS

### 6.62 IN (168 MM) AND 6.8 (172.7 MM) SIZES



2991-ES



24680-ES

6.62 IN (168 MM) C-CLAMP										
Item #	Size in (mm)	Material	ASTM Grade/Class	Thread Type	Eye Screw/T-Handle	Strain Relief?	Jaw Type	Main Line Range	Continuous Current (amps) 60 Hz	Weight ea. lb (kg)
2991-ES	6.62 in (168 mm)	Aluminum	5H / A	Acme	Eye screw	Y	Serrated upper, flat lower	6.12 in I.P.S. 6.62 in to 0.4 in (168 mm to 40 mm) dia.	400 RMS amps, 60 Hz	6.9 lb (3.1 kg)
9967-ES	2.4 in (60.96 mm)	Bronze	5 / A	Acme	Eye screw	N	Smooth upper, flat lower			7.3 lb (3.3 kg)
4378-ES	2.4 in (60.96 mm)	Aluminum	5 / A	Acme	Eye screw	Y	Serrated upper, flat lower			6.9 lb (3.1 kg)

6.8 IN (173 MM) C-CLAMP										
Item #	Size in (mm)	Material	ASTM Grade/Class	Thread Type	Eye Screw/T-Handle	Strain Relief?	Jaw Type	Main Line Range	Continuous Current (amps) 60 Hz	Weight ea. lb (kg)
24680-ES	6.8 in (173 mm)	Aluminum	7 / 7H	Acme	Eye screw	N	Smooth upper, flat lower	6.625 in to 2.375 in (168.2 mm to 60.3 mm) Rounds 6.625 in to 2.5 in (168.2 mm to 63.5 mm)	550 RMS amps, 60 Hz	10.6 lb (4.8 kg)

## UNIVERSAL GROUNDING CLAMPS

### 1.5 IN (38 MM) AND 2.5 IN (63.5 MM) SIZES

The ball and socket grounding system allows for variable angle accessibility. This system is compact and lightweight. There are fixed grounding points on the socket clamp. The 21190 socket clamp, made from bronze alloy, has a socket size of 1 inch (25.4 mm) and a threaded bore boss of 5/8 inch-11 UNC. The socket clamp has an integral cable support with strain relief sleeve.

The ball stud "C" clamp is a universal clamp that can be used in substations and on overhead lines. This universal clamp can be used as a socket clamp on a 1 inch (25.4 mm) ball stud and as a 1.5 inch (38 mm) C-clamp on overhead lines. The eye screw is not extended beyond the body of the clamp, helping minimize possible thread damage during handling. Double lead V-thread allows for faster installation, helping minimize worker fatigue. External and internal ball studs assembly can be used as a current carrying contact stud.

### SPECIFICATIONS FOR BALL STUD "C" CLAMP:

- Aluminum clamp body
- Double lead V-thread eye screw is bronze alloy
- ASTM Type 1, Class A, Grade 5 rating
- Fault current ratings:
  - 43,000 Amps – 15 cycles
  - 30,000 Amps – 30 cycles
- Ferrule attachment:
  - 5/8 inch-11 UNC for Grade 5 rating
- Grounding cable: #2 min size to 4/0 max size

### 1.5 IN (38 MM) UNIVERSAL CLAMP

Item #	Size in (mm)	Material	ASTM Grade/Class	Thread Type	Eye Screw/T-Handle	Strain Relief?	Jaw Type	Main Line Range	Continuous Current (amps) 60 Hz	Weight ea. lb (kg)
22675-ES	1.5 in (38 mm)	Aluminum	5H / A	V thread	Eye screw	Y	Smooth	1431 MCM ACSR to #6 1.5 in to 0.16 in (38 mm to 4 mm)	400 RMS amps, 60 Hz	2.7 lb (1.2 kg)
22704-ES	1.5 in (38 mm)	Aluminum	5H / A	V thread	Eye screw	N	Smooth			2.6 lb (1.2 kg)
22880-ES	1.5 in (38 mm)	Aluminum	5H / A	V thread	Eye screw	Y	Smooth			3.1 lb (1.41 kg)
22881-ES	1.5 in (38 mm)	Aluminum	5H / A	V thread	Eye screw	N	Smooth			3 lb (1.36 kg)

### 2.5 IN (63.5 MM) UNIVERSAL CLAMP

24660-ES	2.5 in (63.5 mm)	Aluminum	7H/A	Acme	Eye screw	N	Smooth	0.4 in to 2.5 in (10 mm to 63.5 mm) and 1.4 in (35 mm) ball stud	550 RMS amps, 60 Hz	6.8 lb (3.08 kg)
----------	------------------	----------	------	------	-----------	---	--------	--	---------------------	------------------

## FLAT JAW GROUNDING CLAMPS

### 1.5 IN (38 MM)

Flat jaw grounding clamps are available with either a large "T" handle or with an eye for clampstick application. The handles and eyes are designed so that the cable will not interfere with the torquing of the clamp. The set screw that secures the clamp to a flat surface is located on the movable jaw on all designs. When tightened, the set screw forces the fixed jaw of the clamp firmly against the flat ensuring a consistent low resistance current path directly through the body of the clamp to the cable connection. With other designs having a set screw on the fixed jaw, current is required to flow through mechanical connections between the movable jaw, the eye screw and the body of the clamp before passing to the cable connection.



1814-ES

1815-ES

### 1.5 IN (38 MM) FLAT JAW CLAMPS

Item #	Size in (mm)	Material	ASTM Grade/Class	Thread Type	Eye Screw/T-Handle	Strain Relief?	Jaw Type	Main Line Range	Continuous Current (amps) 60 Hz	Weight ea. lb (kg)
1814-ES	1.5 in (38 mm)	Bronze	3 / B	V-thread	T Handle	Y	Serrated	1.5 in to 0.06 in Flat or square	300 RMS amps, 60 Hz	1.7 lb (0.8 kg)
1815-ES	1.5 in (38 mm)	Bronze	3 / B	V-thread	Eye Screw	Y	Serrated			1.6 lb (0.7 kg)
24405-ES	1.5 in (38 mm)	Aluminum	5 / B	Acme	T Handle	N	Serrated	1.26 in to 0.06 in (32 mm to 1.5 mm) dia.	400 RMS amps, 60 Hz	2.1 lb (0.9 kg)
4345-ES	1.5 in (38 mm)	Aluminum	5 / B	Acme	T Handle	Y	Serrated			2.1 lb (0.9 kg)
24442-ES	1.5 in (38 mm)	Aluminum	5 / B	Acme	T Handle	Y	Serrated			2.1 lb (0.9 kg)

### 1.5 IN (38 MM) UNIVERSAL CLAMP

Item #	Size in (mm)	Material	ASTM Grade/Class	Thread Type	Eye Screw/T-Handle	Strain Relief?	Jaw Type	Main Line Range	Continuous Current (amps) 60 Hz	Weight ea. lb (kg)
4369-ES	1.5 in (38 mm)	Aluminum	5 / B	Acme	Eye crew	Y	Serrated	1.5 in to 0.06 in (38.1 mm to 1.5 mm) Flat or square	400 RMS amps, 60 Hz	2 lb (0.9 kg)
24441-ES	1.5 in (38 mm)	Aluminum	5 / B	Acme	Eye screw	Y	Serrated			2 lb (0.9 kg)
9974-ES		Bronze	5 / B / 5H	Threaded	Rod	Y	Serrated	Angles & flats: 2.5 in to 4 in WX (64 mm to 101 mm x 3 mm to 19 mm)	400 RMS amps, 60 Hz	4.1 lb (1.8 kg)
24649-ES	1.5 in (38 mm)	Aluminum	5H	V-thread	T-handle	Y	Serrated	Rounds: 0.25 in to 0.75 in (6 mm to 19 mm) dia.		2.28 lb (1.03 kg)
24650-ES	1.5 in (38 mm)	Aluminum	5H	V-thread	Eye screw	Y	Serrated			2.28 lb (1.03 kg)

## ALL ANGLE CLAMPS

### 2.5 IN (63.5 MM)

2.5 IN (63.5 MM) ALL ANGLE CLAMPS										
Item #	Size in (mm)	Material	ASTM Grade/Class	Thread Type	Eye Screw/T-Handle	Strain Relief?	Jaw Type	Main Line Range	Continuous Current (amps) 60 Hz	Weight ea. lb (kg)
<b>22885-ES</b>	2.5 in (63.5 mm)	Aluminum	5 / B	Threaded	Bronze Posigrip	Y	Serrated	0.25 in to 2.5 in (6 mm to 63.5 mm)	400 RMS amps, 60 Hz	4.3 lb (2 kg)
<b>22903-ES</b>	2.5 in (63.5 mm)	Aluminum	5 / B	Threaded	Mounted	Y	Serrated		400 RMS amps, 60 Hz	4.3 lb (2 kg)

## SPECIALTY CLAMPS

The running power rail ground set is made up of 7561A power rail clamp and 7560 running rail clamp connected with three feet (91.4 cm) of 4/0 PVC-jacketed copper cable. Set includes one 10024BC, 1 in x 24 in (2.5 x 61 cm) fiberglass handle with bayonet to operate the power rail clamp.

The ball and socket grounding system has a lightweight compact design and allows for variable angle accessibility. These clamps are made from bronze alloy and have a socket size of 1in (25.4 mm) with a threaded bore boss of 5/8 in-11 UNC. There are fixed grounding points on the socket clamp.

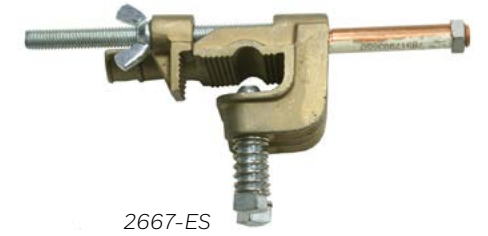

2667-ES

C-CLAMP - HEAVY DUTY										
Item #	Size in (mm)	Material	ASTM Grade/Class	Thread Type	Eye Screw/T-Handle	Strain Relief?	Jaw Type	Main Line Range	Continuous Current (amps) 60 Hz	Weight ea. lb (kg)
<b>2667-ES</b>	0.625 in (15.9 mm)	Bronze	5/B	N/A	Rod	N	Serrated	Angles & Flats: 2.5 in to 4 in WX (64 mm to 101.3 mm to 19 mm) Rounds: 0.25 in to 0.75 in (6 mm to 19 mm) dia.	400 RMS amps, 60 Hz	5 lb (2.7 kg)



## SPECIALTY CLAMPS

Cutout clamps are applied with a clampstick into the bottom hinge contact of a cutout. This clamp can be used as part of a ground assembly or by using a contact stud using a standard grounding assembly with "C" clamps from the stud to ground.

Lightweight, heavy duty stringing ground installs anywhere along the length of conductor to provide a continuous grounding bond, even if the conductor is slack. Constructed of high-strength aluminum alloy with large diameter sheaves and bronze bushing bearings. Features a side opening for quick, easy installation. Adjustable compression spring assures proper contact for different sizes of conductors and for easy passage of splices. In tests, this clamp withstood a 25 kA, 28 cycle short circuit. The three options for a ground tap connection are: termination for ground cables, contact/hanger stud and connector for ground wire.

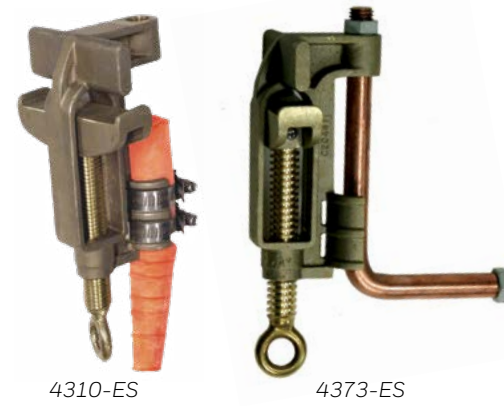

CUTOUT CLAMPS								
Item #	Description	Material	ASTM Grade/Class	Thread Type	Eye Screw/T-Handle	Tap Size	Continuous Current (amps) 60 hz	Weight ea. lb (kg)
4310-ES	Bronze cutout clamp with ferrule connection	Bronze	5	V-thread	Eye screw	5/8 - 11 UNC Max. cable size 470 type	400 RMS amps, 60 Hz	2.1 lb (1.1 kg)
4373-ES	Bronze cutout clamp with contact stud	Bronze	5	V-thread	Eye screw	VI compression ferrules		3.3 lb (1.5 kg)

## HANGER STUD

Hanger studs are designed to be used with all "C" and duck bill ground clamps. Hanger Studs are used to hold one clamp of a set while the other is being installed on the de-energized line. Hanger studs are not designed or tested to carry current.

HANGER STUDS		
Item #	For use with	Material
1928-ES	Aluminum C-clamp 1.25 in / 1.5 in / 2.4 in / 3.5 in (31.75 mm / 38 mm / 61 mm / 89 mm)	Aluminum
2427-ES	Aluminum C Clamp 1.25 in / 1.5 in / 2.4 in / 3.5 in (31.75 mm / 38 mm / 61 mm / 89 mm)	Aluminum
2093-ES	Bronze Duckbill, 477 Bronze, C-clamp	Brass
9983-ES	Brass C Clamp - 1 in / 1.25 in / 2.4 in (25.4 mm / 31.75 mm / 61 mm)	Brass
22742-ES	All Duckbill Clamp	Aluminum
21204-ES	All Duckbill Clamp	Brass



## BALL & SOCKET SYSTEM



21190-ES

SOCKET CLAMPS									
Item #	Description	Material	ASTM Grade/Class	Thread Type	Fits Ball Studs:	Eye Screw/T-Handle	Strain Relief?	Continuous Current (amps) 60 hz	Weight ea. lb (kg)
21190-ES	Bronze socket clamp	Bronze	5	V Thread	1 in (25.4 mm)	Eye screw	Y	400 RMS amps, 60 Hz	1.2 lb (0.54 kg)
21277-ES	Bronze socket clamp	Bronze	5	V Thread	1 in (25.4 mm)	Eye screw	N		1.1 lb (0.5 kg)

## BALL STUDS

The ball studs and the offset Nema pad ball studs are made from tin-plated copper alloy or copper. They each have a 1 in (25.4 mm) diameter ball. Recommended installation torque of 300 in. lbs. The short stud is used conventionally. The long stud can also be used as the grounding point for "C" or Duck bill clamps that have a jaw width of 2.75 in (69.85 mm) or less. The offset Nema pad ball stud has the standard Nema bolt hole spacing and also comes in both long and short lengths.

The ball stud cover is made from orange SALCOR® which allows for multiple angle application when installed using a clampstick.



BALL STUDS						
Item #	Description	ASTM Grade/Class	Overall Length in (mm)	Thread Dimensions in (mm)	Shank Dimensions in (mm)	Weight ea. lb (kg)
21191-ES	Short ball stud, tin-plated copper	5	4.38 in (111 mm)	2.1 in (54 mm)	1 in (25.4 mm)	0.53 lb (0.24 kg)
21192-ES	Long ball stud, tin-plated copper	5	6.13 in (156 mm)	2.1 in (54 mm)	2.75 (70 mm)	0.8 lb (0.36 kg)
24082-ES	Internal thread ball stud, tin-plated copper	5	3.85 in (98 mm)	1.5 (38 mm)	0.75 in (19 mm)	0.54 lb (0.24 kg)
21989-ES	Short ball stud	5	3 in (76.2 mm)	1.6 in (41 mm)	1 in (25.4 mm)	0.53 lb (0.24 kg)
24662-ES	Ball stud, tin-plated copper	7 / 7H	5.5 in (139.7 mm)	2.1in (54 mm)	1.37 in (35 mm)	1.5 lb (0.7 kg)

## NEMA PAD STUDS & CONTACT STUD



NEMA PAD STUDS					
Item #	Description	ASTM Grade/Class	Overall Length in (mm)	Shank Dimensions in (mm)	Weight ea. lb (kg)
21228-ES	Short offset NEMA pad, tin-plated copper alloy	5	5.14 in (131 mm)	1 in (25.4 mm)	14 lb (6.3 kg)
21846-ES	90 offset NEMA pad, tin-plated copper alloy	5	5.75 in (147 mm)	3 in (76 mm)	0.8 lb (0.36 kg)
24087-ES	Long offset NEMA Pad, tin-plated copper alloy	5H	6.9 in (175 mm)	1 in (25.4 mm)	0.53 lb (0.24 kg)

CONTACT STUDS					
Item #	Description	ASTM Grade/Class	Overall Length in (mm)	Shank Dimensions in (mm)	Weight ea. lb (kg)
2402-ES	Contact stud	3	—	—	—
4379-ES	Contact stud	5	—	—	—

## GROUNDING ACCESSORIES

HEAT SHRINK	
Item #	Description
20886-ES	5 in (127 mm) Heat shrink tube, clear
21935-ES	1.5 in (38 mm) Heat shrink, tube, clear
761ST-ES	6 in (153 mm) Heat shrink tube with adhesive, clear
762ST-ES	6 in (153 mm) Heat shrink tube, clear
22005-ES	6 in (153 mm) Heat shrink tube, clear
22708-ES	7 in (178 mm) Heat shrink tube, clear
22681-ES	7 in (178 mm) Heat shrink tube, clear

## STRAIN RELIEF SLEEVES

Strain relief sleeves reinforce cables at the termination points when used with the cable support system. This decreases strand damage to cables from age or mishandling which reduces current carrying capacity and service life. SALCOR® Strain Relief Sleeves accept all grounding cables #2 through 4/0. Sleeve assembly consists of two parts: the inner sleeve, which is discarded if the cable diameter exceeds 0.72 in (18.28 mm) and tapered outer sleeve, 6.5 in (165.1 mm) long, which can be cut to match the diameters. Clear strain relief sleeves and heat shrink are available to fit ground clamps.

CABLE STRAIN RELIEF SLEEVE		
Item #	Description	Weight Ea. lb (kg)
1758	Inner SALCOR® sleeve only	0.1 lb (0.04 kg)
1788	Complete SALCOR® strain relief assembly	0.1 lb (0.04 kg)
2633	Clear sleeve for 4/0 grounding cable	0.1 lb (0.04 kg)
2893	Clear sleeve for #2 to 2/0 grounding cable	0.1 lb (0.04 kg)
20886	Clear heat shrink, 5 in (127 mm) for all grounding cables	0.1 lb (0.04 kg)



## GROUNDING CABLES

Salisbury grounding cables are made with extra flexible strand of soft drawn #30 AWG 0.01 in (0.25 mm) copper and are available in three different jackets.

Salisbury yellow and black ground cable now include permanent embossed markings.

The yellow thermoplastic elastomer jacketed cable is the standard for grounding service. It provides a combination of economy, flexibility and durability. The service temperature ranges from 200°F to -50°F. ASTM F 855 Type I.

The black thermoplastic elastomer jacketed cable has a smaller diameter and thinner jacket material giving it better flexibility than the yellow cable. The service temperature ranges from 200°F to -50°F. ASTM F 855 Type I.

The PVC transparent flexible thermoplastic jacketed cable allows easy inspection for strand breakage. The flexibility decreases with low temperatures. The service temperature ranges from 140° F to -40°F per ASTM F 855, Type III requirements.



YELLOW JACKET								
Item #	Color	Size	Strand Dia. in (mm)	Jacket Dia. in (mm)	Short Circuit Withstand amps, RMS, 60 Hz		Continuous Current (amps) 60hz	Weight / 1000 ft. lb (kg)
					15 Cycles	30 Cycles		
<b>2136-ES</b>	Yellow	#2-665W	0.4 in (10.3 mm)	0.49 in (12.37 mm)	14500	10000	200	282 lb (127 kg)
<b>2137-ES</b>	Yellow	1/0-1064W	0.46 in (11.76 mm)	0.55 in (13.87 mm)	21000	15000	250	488 lb (221 kg)
<b>2138-ES</b>	Yellow	2/0-1330W	0.55 (13.97 mm)	0.65 in (16.38 mm)	27000	20000	300	537 lb (243 kg)
<b>2139-ES</b>	Yellow	4/0-2109W	0.64 (16.26 mm)	0.74 in (18.67 mm)	43000	30000	400	836 lb (379 kg)
<b>24667-ES</b>	Yellow	350 kcmil	0.89 (22.61 mm)	1 in (25.4 mm)	74000	54000	550	
BLACK JACKET								
<b>2637-ES</b>	Black	1/0-1064W	0.45 in (11.4 mm)	0.58 in (14.73 mm)	21000	15000	250	404 lb (183 kg)
<b>2639-ES</b>	Black	4/0-2109W	0.66 in (16.64 mm)	0.75 in (19.05 mm)	43000	30000	400	770 lb (349 kg)
CLEAR PVC JACKET								
<b>2128-ES</b>	Clear PVC	#2-665W	0.35 in (8.9 mm)	0.45 in (11.46 mm)	14500	10000	200	289 lb (131 kg)
<b>2288-ES</b>	Clear PVC	4/0-2109W	0.52 in (13.21 mm)	0.81 in (20.45 mm)	43000	30000	400	841 lb (381 kg)

## GROUNDING CABLES 500 FT REELS

YELLOW JACKET								
Item #	Color	Size	Strand Dia. in (mm)	Jacket Dia. in (mm)	Short Circuit Withstand amps, RMS, 60 Hz		Continuous Current (amps) 60hz	Weight / 1000 ft. lb (kg)
					15 Cycles	30 Cycles		
<b>2136-500R-ES</b>	Yellow	#2-665W	0.4 in (10.3 mm)	0.49 in (12.37 mm)	14500	10000	200	282 lb (127 kg)
<b>2137-500R-ES</b>	Yellow	1/0-1064W	0.46 in (11.76 mm)	0.55 in (13.87 mm)	21000	15000	250	488 lb (221 kg)
<b>2138-500R-ES</b>	Yellow	2/0-1330W	0.55 (13.97 mm)	0.65 in (16.38 mm)	27000	20000	300	537 lb (243 kg)
<b>2139-500R-ES</b>	Yellow	4/0-2109W	0.64 (16.26 mm)	0.74 in (18.67 mm)	43000	30000	400	836 lb (379 kg)
<b>24667-500R-ES</b>	Yellow	350 kcmil	0.89 (22.61 mm)	1 in (25.4 mm)	74000	54000	550	
BLACK JACKET								
<b>2637-500R-ES</b>	Black	1/0-1064W	0.45 in (11.4 mm)	0.58 in (14.73 mm)	21000	15000	250	404 lb (183 kg)
CLEAR PVC JACKET								
<b>2128-500R-ES</b>	Clear PVC	#2-665W	0.35 in (8.9 mm)	0.45 in (11.46 mm)	14500	10000	200	289 lb (131 kg)
<b>2129-500R-ES</b>	Clear PVC	1/0-1064W	0.45 in (11.4 mm)	0.55 in (13.87mm)	21000	15000	250	520 lb (235 kg)
<b>2133-500R-ES</b>	Clear PVC	2/0-1330W	0.49 in (12.45 mm)	0.63 in (15.98 mm)	27000	20000	300	546 lb (247 kg)
<b>2288-500R-ES</b>	Clear PVC	4/0-2109W	0.52 in (13.21 mm)	0.81 in (20.45 mm)	43000	30000	400	841 lb (381 kg)

## PLAIN SHROUDED & UNSHROUDED FERRULES

Plain ferrules are designed for use with all grounding clamps that feature pressure terminals including the 1 in (25 mm) duckbill and 1.5 in (38 mm) flat jaw clamp.

Copper ferrules are available in two different styles: unshrouded and shrouded. Shrouded ferrules are compressed on both the conductor and the jacket of the cable to reduce bending stress. Unshrouded ferrules are crimped on the conductor strands only. These ferrules are manufactured of tin plated, 99.5 % pure copper.

Aluminum Ferrules are available in two different styles: unshrouded and shrouded. Shrouded ferrules are compressed on both the conductor and the jacket of the cable to reduce bending stress. Unshrouded ferrules are crimped on the conductor strands only.

Tin plated copper ferrules can be used on either bronze or aluminum body clamps. All Salisbury threaded grounding ferrules are unshrouded and manufactured with a 5/8-11 UN C threaded stud and meets the requirements of ASTM F855.



Aluminum plain shrouded



Aluminum plain unshrouded

### COPPER, TIN-PLATED SHROUDED FERRULE

Item #	Material	Shrouded/Unshrouded	Cable Size	Length in (mm)	Strand Dia. Codes T & B	Jacket Die Codes T & B	Burndy Die Number	Weight Ea. Pair lb (kg)
24424-ES	Copper Tin-plated	Shrouded	#2	4.5 in (114.3 mm)	50	71	—	0.30 lb (0.14 kg)
24425-ES	Copper Tin-plated	Shrouded	1/0	4.5 in (114.3 mm)	50	71	—	0.35 lb (0.16 kg)
24426-ES	Copper Tin-plated	Shrouded	2/0	4.5 in (114.3 mm)	60	76	—	0.40 lb (0.18 kg)
24427-ES	Copper Tin-plated	Shrouded	4/0	4.5 in (114.3 mm)	66	106	—	0.45 lb (0.20 kg)
24148-ES	Copper Tin-plated	Shrouded	#2	3.8 in (96.52 mm)				
22790-ES	Copper Tin-plated	Shrouded	1/0	3.8 in (96.52 mm)				
24166-ES	Copper Tin-plated	Shrouded	4/0	3.8 in (96.52 mm)				
22789-ES								
24714-ES	Copper Tin-plated	Shrouded	4/0	4.93 in (125.2 mm)				0.6 lb (0.03 kg)

### COPPER, TIN-PLATED UNSHROUDED FERRULE

24420-ES	Copper Tin-plated	Unshrouded	#2	3.8 in (96.52 mm)	50	—	—	0.30 lb (0.14 kg)
24421-ES	Copper Tin-plated	Unshrouded	1/0	3.8 in (96.52 mm)	50	—	U234	0.30 lb (0.14 kg)
24422-ES	Copper Tin-plated	Unshrouded	2/0	3.8 in (96.52 mm)	60	—	U245	0.35 lb (0.16 kg)
24423-ES	Copper Tin-plated	Unshrouded	4/0	3.8 in (96.52 mm)	66	—	U247	0.35 lb (0.16 kg)

## PLAIN SHROUDED & UNSHROUDED FERRULES

### ALUMINUM SHROUDED FERRULE

Item #	Material	Shrouded/Unshrouded	Cable Size	Length in (mm)	Strand Dia. Codes T & B	Jacket Die Codes T & B	Burndy Die Number	Weight Ea. Pair lb (kg)
24434-ES	Aluminum	Shrouded	#2	4.5 in (114.3 mm)	50	71	—	0.1 lb (0.05 kg)
24436-ES	Aluminum	Shrouded	2/0	4.5 in (114.3 mm)	60	76	—	0.15 lb (0.07 kg)
24437-ES	Aluminum	Shrouded	4/0	4.5 in (114.3 mm)	71	106	—	0.15 lb (0.07 kg)

### ALUMINUM-UNSHROUDED FERRULE

24430-ES	Aluminum	Unshrouded	#2	3.8 in (96.52 mm)	50	—	—	0.12 lb (0.05 kg)
24431-ES	Aluminum	Unshrouded	1/0	3.8 in (96.52 mm)	50			0.12 lb (0.05 kg)
24432-ES	Aluminum	Unshrouded	2/0	3.8 in (96.52 mm)	60			0.16 lb (0.07 kg)
24433-ES	Aluminum	Unshrouded	4/0	3.8 in (96.52 mm)	71			0.16 lb (0.07 kg)

### ALUMINUM THREADED UNSHROUDED FERRULES

2026-ES	Aluminum	Unshrouded	#2	3 in (76.2 mm)	50		U243	0.2 lb (0.1 kg)
2027-ES	Aluminum	Unshrouded	1/0	3 in (76.2 mm)	50		U243	0.2 lb (0.1 kg)
2620-ES	Aluminum	Unshrouded	2/0	3 in (76.2 mm)	60		U245	0.2 lb (0.1 kg)
2640-ES	Aluminum	Unshrouded	4/0	3 in (76.2 mm)	71		U694	0.2 lb (0.1 kg)

### COPPER TIN-PLATED, THREADED UNSHROUDED FERRULES

2022-ES	Copper Tin-plated	Unshrouded	#2	3 in (76.2 mm)	50		U243	0.5 lb (0.2 kg)
2023-ES	Copper Tin-plated	Unshrouded	1/0	3 in (76.2 mm)	50		U243	0.4 lb (0.18 kg)
2024-ES	Copper Tin-plated	Unshrouded	2/0	3 in (76.2 mm)	60		U245	0.4 lb (0.18 kg)
4277-ES	Copper Tin-plated	Unshrouded	3/0	3 in (76.2 mm)	66			0.6 lb (0.27 kg)
2025-ES	Copper Tin-plated	Unshrouded	4/0	3 in (76.2 mm)	66		U247	0.6 lb (0.27 kg)
22864-ES	Copper Tin-plated	Unshrouded	#2	3.63 in (92.2 mm)				
22788-ES	Copper Tin-plated	Unshrouded	1/0	3.63 in (92.2 mm)				
22871-ES	Copper Tin-plated	Unshrouded	2/0	3.63 in (92.2 mm)				
22784-ES	Copper Tin-plated	Unshrouded	4/0	3.63 in (92.2 mm)				
24668-ES	Copper Tin-plated	Unshrouded	350 KCMIL	3.63 in (92.2 mm)				

### COPPER SHROUDED

21354-ES	Copper	Shrouded	2/0	4.8 in (122 mm)	66	112	—	1.10 (0.5 kg)
9879-ES	Copper	Shrouded	2/0				U243	

## THREADED & PIN FERRULES FOR SAFETY LINE SETS

For threaded ferrules (terminals) the recommended torque applied during installation of jam nut for threaded ferrules is 20 ft.-lb. These threaded ferrules include one brass jam nut and one lock washer. For pin terminals the recommended torque applied during installation of pin ferrule eye bolts is 28 ft.-lb.



76CT43-ES

Grounding cables are made with extra flexible strand of soft drawn #30 AWG 0.01 in (0.25 mm) copper and are available in three different jackets.

## SINGLE GROUNDING ASSEMBLIES

Salisbury offers a variety of single grounding versatility to the user when performing temporary grounding.

For ordering convenience, completed single grounding assemblies are listed which cover many standard application needs. Modification to these sets to meet specific needs can be made.

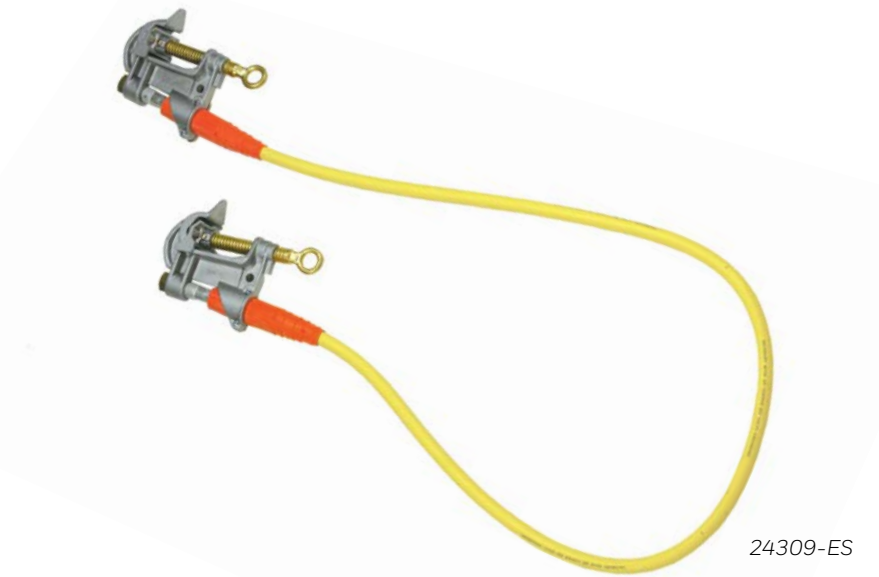

24309-ES

COPPER THREADED UNSHROUDED FERRULES								
Item #	Material	Shrouded/Unshrouded	Cable Size	Length in (mm)	Strand Dia. Codes T & B	Jacket Die Codes T & B	Burndy Die Number	Weight Ea. Pair lb (kg)
<b>24326-ES</b>	Copper	Unshrouded	2/0	4 in (101.6 mm)				
COPPER PIN UNSHROUDED FERRULES								
<b>24420-ES</b>	Copper Tin-Plated	Unshrouded	#2	3.8 in (96.52 mm)	50	—	—	0.30 lb (0.14 kg)
<b>24421-ES</b>	Copper Tin-Plated	Unshrouded	1/0	3.8 in (96.52 mm)	50	—	U234	0.30 lb (0.14 kg)
<b>24422-ES</b>	Copper Tin-Plated	Unshrouded	2/0	3.8 in (96.52 mm)	60	—	U245	0.35 lb (0.16 kg)
<b>24423-ES</b>	Copper Tin-Plated	Unshrouded	4/0	3.8 in (96.52 mm)	66	—	U247	0.35 lb (0.16 kg)
COPPER THREADED SHROUDED FERRULES								
<b>76CT43-ES</b>	Copper	Shrouded	4/0		T&B 66	B75-AH		

SINGLE GROUNDING ASSEMBLIES			
Item #	Description	ASTM Grade	Weight ea. lb (kg)
<b>24309-ES</b>	(2) 1895-ES Serrated aluminum C-clamp 1.5 in (38.1 mm) (1 pair) 2024-ES 2/0 Unshrouded tin-plated ferrules (1) 6 ft (1.8 m) 2138-ES 2/0 Cu. yellow cable	3	5.9 lb (2.7 kg)
<b>24310-ES</b>	(1) 1895-ES Serrated aluminum C-clamp 1.5 in (38.1 mm) (1) 4345-ES Flat jaw T-handle clamp (2) 2024-ES Unshrouded cu. ferrule (1) 6 ft (1.8 m) 2138-ES 2/0 Yellow ground cable	3	
<b>2299-ES</b>	(2) 1895 Serrated aluminum "C" clamp 1.5 in (38,1 mm) (2) 2027-ES 1/0 AL unshrouded ferrule (1) 1928-ES Hanger stud AL (1) 6 ft (1.8 m) 2137-ES 1/0 Yellow cable	2	5.9 lb (2.7 kg)
<b>21100-ES</b>	(2) 4200-ES Bronze C-clamp (2) 2024-ES Unshrouded cu. ferrule (1) 3 ft (0.9 m) 2138-ES 2/0 Yellow ground cable	3	
<b>2319-ES</b>	(2) 1923-ES C-clamp (2) 2620-ES Unshrouded AL ferrule (1) 1928-ES Hanger stud (1) 10 ft (3 m) 2138-ES Yellow ground cable	3	8.7 lb (3.9 kg)
<b>2320-ES</b>	(1) 1923-ES C-clamp (1) 4345-ES Flat jaw T-handle (2) 2620-ES Unshrouded AL ferrule (1) 15 ft (4.6 m) 2138-ES 2/0 Yellow ground cable	3	7.4 lb (3.4 kg)
<b>2329-ES</b>	192-ES C-clamp (2) 2620-ES Unshrouded aluminum ferrule (1) 1928-ES AL hanger stud (1) 10 ft (3m) 2138-ES 2/0 Yellow ground cable	3	9 lb (4.1 kg)
<b>2876-ES</b>	(2) 1 in (25.4 mm) 2531-ES Smooth aluminum C-clamp (1) 2537-ES Hanger stud (2) 2027 Ferrules (1) 6 ft (1.8 m) 2137 1/0 Cu. yellow cable	2	4.9 lb (2.2 kg)
<b>9975-ES</b>	(2) 1 in (25.4 mm) 9985-ES Smooth bronze C-clamp (1) 9983-ES Hanger stud (2) 2023-ES Ferrules (1) 6 ft (1.8 m) 2137-ES 1/0 Yellow cable	2	6.9 lb (3.1 kg)
<b>21184-ES</b>	(1) 4260-ES Bronze C-cl (1) 2023-ES Unshrouded Cu. ferrule (1) 2910-ES 1/0 Ground elbow (1) 6 ft (1.8 m) 2137-ES 1/0 Yellow ground cable	2	

Optional ground set label available upon request when ordering.

## GROUNDING ASSEMBLIES

### SINGLE-POINT DISTRIBUTION GROUNDING SETS & SPECIAL APPLICATION SETS

A single-point distribution grounding set creates an equal potential zone on the working structure. This is accomplished by bonding all conductors and the structure to a ground source using individual assemblies as shown in the adjacent drawing.

The special applications grounding sets listed are some typical complete personal protection ground sets for common line construction. These sets, although practical for many applications, are shown as a guide to help determine individual system needs and for ease of ordering. Variations of these sets may be requested to meet specific situations or user preferences. Your local Salisbury representative can answer any questions you have on personal protection grounding needs and applications.

SINGLE-POINT GROUNDING ASSEMBLIES			
Item #	Description	ASTM Grade	Weight ea. lb (kg)
4246-ES	(10) 2531-ES Smooth aluminum C-clamp (1) 9998-ES Aluminum pole mount contact bar (5 pair) 2026-ES Ferrule (3) 2537-ES Hanger stud (1) 60 ft (18.3 m) 2636-ES Cu. cable (1) 2103-ES Screw ground rod with connector	1	45.5 lb (20.6 kg)
COMPLETE THREE-PHASE DELTA			
2684-ES	(2) 20880-ES Contact bar (7) 1.5 in (0.04 mm) 1895-ES Serrated aluminum C-clamp (1) 84 ft (25.6 m) 2637-ES 1/0 Cu. black cable (4 pair) 2027-ES ferrule (2) 1928-ES Hanger stud (1) 2654-ES storage bag (1) 2103-ES Screw ground rod	2	5.9 lb (2.7 kg)
4249-ES	(2) 2088-ES Contact bar (7) 1.5 in (0.04 mm) 2531-ES Smooth aluminum C-clamp (1) 84 ft (25.6 m) 2637-ES 1/0 Cu. black cable (4 pair) 2027-ES Ferrule (2) 2537-ES Hanger studs (1) 2654-ES Storage bag (1) 2103-ES Screw ground rod	3	8.7 lb (3.9 kg)
FOUR-WAY GROUND SET			
24308-ES	(1) 2374-ES four-way connector (4) 1.5 in (0.04 mm) 1895-ES Serrated aluminum C-clamp (1) 2427-ES Double hanger stud (1) 2402-ES Contact stud (8) 2924-ES 2/0 Unshrouded ferrule (1) 10 ft (3 m), (1) 6 ft x 3 ft (1.8 m x 0.9 m) 2138-ES 2/0 Yellow cable	3	
24307-ES	(1) 2374-ES four-way connector (3) 21190-ES Clamp (1) 31814-ES FJ Bronze T-handle clamp (8) 2024-ES Unshrouded cu ferrule (1) 10 ft (3 m), (1) 6 ft x 3 ft (1.8 m x 0.9 m) 2138-ES 2/0 Yellow ground cable	3	
2680-ES	(1) 2374-ES four-way connector (4) 1895-ES C-clamp (1) 2427-ES Double hanger stud (1) 2402-ES Contact stud (8) 2027-ES Unshrouded cu. ferrule (2) 10 ft (3 m), (1) 8 ft (2.3 m), (1) 6 ft (1.8 m) 2138-ES 2/0 Yellow ground cable	2	

Optional ground set label available upon request when ordering.

## GROUNDING SETS

### THREE-WIRE UNIVERSAL GROUNDING CLUSTERS & SETS

Grounding clusters are used to make it easy for a single line worker to apply multiple grounding assemblies on a three phase system. All clusters have an option of a ground lead by using the extra connection point on each cluster. Three wire clusters are recommended for three phase Delta systems. Complete grounding cluster assemblies are available from the factory. By specifying the cable size and length required, the assembly will be made to your specifications.

GROUNDING CLUSTERS			
Item #	Description	ASTM Grade	Weight ea. lb (kg)
4248-ES	(1) 1790-ES Duckbill cluster (1) 76 ft (23.2 m) 2636-ES #2 Cable (3 pairs) 2022-ES Ferrule (1) 2103-ES Screw ground rod (1) 2654-ES Storage bag	4	54.2 lb (24.6 kg)
1957-ES	(1) 1774-ES Cluster bag (3) 1.5 in (38.1 mm) 1895-ES Aluminum C-clamps	5	6.4 lb (2.9 kg)

Clusters are also available with mounted clamps, consult the factory for more information. Optional ground set label available upon request when ordering.

## GROUNDING SETS & FOUR-WAY CONNECTORS

### FOUR-WIRE UNIVERSAL GROUNDING CLUSTERS & SETS

Grounding clusters make it easy for a single line worker to apply multiple grounding assemblies. All clusters have an option of a ground lead by using the extra connection point on each cluster. Four wire clusters are recommended for three-phase Wye systems. Complete grounding cluster assemblies are available from the factory. By specifying the cable size and length required, the assembly will be made to your specifications.

The 2680 four-way connector ground set provides an excellent system for the grounding of a three-phase system.

Four-way connectors are used to create a common connection between the conductor leads and the ground lead of a ground set.

FOUR-WIRE UNIVERSAL GROUNDING CLUSTERS & SETS			
Item #	Description	ASTM Grade	Weight ea. lb (kg)
<b>2682-ES</b>	(1) 1794-ES four-wire cluster (6) 2022-ES #2 Unshrouded cu. ferrule (1) 3 ft x 6 ft (0.9 m x 1.8 m) 2636-ES #2 black cable (1) 2654-ES Nylon bag	4	14.5 lb (6.6 kg)
<b>2374-ES</b>	Threaded ferrule four-way connector	5	1.8 lb (0.8 kg)
<b>21702-ES</b>	Threaded ferrule four-way connector	5	0.5 lb (0.23 kg)
<b>24438-ES</b>	Plain ferrule four-way connector	5	2 lb (0.9 kg)

Optional ground set label available upon request when ordering.

## GROUNDING SETS

### DEAD FRONT GROUNDING JUMPERS & ELBOWS

Both 15 kV and 25 kV elbows are available with connectors for 1/0 or 2/0 cable. Assembled sets for 15 kV and 25 kV are available for single phase or three-phase grounding requirements. The fault duty rating for 200 amp grounding elbows is 10 kA for 10 cycles per IEEE 386. Standard three-phase sets have a 4 ft (1.2 m) tail connecting to a 2374 four-wire connector with 2 ft (0.6 m) leads for the elbows. Sets can be factory assembled to customer specifications.

GROUND ELBOWS		
Item #	Description	Weight ea. lb (kg)
<b>2910-ES</b>	15 kV Elbow with 1/0 cable connector	1.7 lb (0.7 kg)
<b>2912-ES</b>	15 kV Elbow with 2/0 cable connector	1.7 lb (0.7 kg)
<b>2935-ES</b>	25 kV Elbow with 1/0 Cable Connector	2 lb (0.9 kg)
<b>2936-ES</b>	25 kV Elbow with 2/0 Cable Connector	2 lb (0.9 kg)

Optional ground set label available upon request when ordering.

## GROUNDING ACCESSORIES

Pole mounted contact bars are designed to act as a convenient common point for electrical connections and also as a hanger for grounding sets during installation and removal.

Supplied with a chain and an adjustable wheel binder that will accommodate most common pole diameters. The Salisbury 21840-ES is a lighter-weight pole mounted contact bar.

The Salisbury 2103-ES screw type temporary ground rod is used when an adequate system ground is not available. The design incorporates a copperweld rod with bronze fittings screwed and pinned on both ends. The terminal on the handle is designed to accept cables equipped with a 5/8-11 UNC threaded ferrule. As an alternative, a "C" clamp may also be attached directly to the ground rod shaft.

### SCREW GROUND ROD

Item #	Description	Weight Ea lb (kg)
<b>2103-ES</b>	75 in (1.9 m) long	8 lb (3.6 kg)

### POLE MOUNTED CONTACT BARS

Item #	ASTM Grade	Description	Weight Ea. lb (kg)
<b>9998-ES</b>	5	Contact bar no connection 40 in (1.02 m) chain with adjustable wheel binder	9.1 lb (4.1 kg)
<b>21840-ES</b>	5	Contact bar no connection 40 in (1.02 m) chain with adjustable wheel binder	7 lb (3.3 kg)



## HYDRAULIC CABLE SPIKE

The hydraulic cable spike is designed to verify that underground cable, up to 1000 MCM, is de-energized before cutting, repairing, splicing or replacing.

The cable spike, a solid brass body with a stainless steel piercing tip, is fitted to hydraulic compression tools so that the cable can be accurately spiked from a safe distance. An anodized aluminum insert is included to position the cable precisely.

The cable penetrating ground clamp is designed to be used either as a tool for "spiking" jacketed cable or as a part of a grounding assembly used to bond both ends of an opened cable. The 7/8 in long plated steel point is inserted into the eye screw making a low resistant one piece spear. If one point becomes blunted it may be sharpened or replaced with a new spear. Clamps are aluminum body with either smooth or serrated upper jaws. The hard aluminum serrated insert

### HYDRAULIC CABLE SPIKE

Item #	Cable Length ft (mm)	Description Spiking Tool & Ground Assembly:	Weight Ea lb (kg)
<b>24320</b>	6 ft (1.8 m)	2139-ES 4/0 Yellow ground cable (2) 2025-ES 4/0 Unshrouded copper	9.5 lb (4.3 kg)
<b>24321</b>	8 ft (2.4 m)	Ferrule Cable spiking tool & insert 4388-ES 1 in (25.4 mm) C-clamp	11.2 lb (5.1 kg)
<b>24322</b>	10 ft (3 m)	JCM-001-ES Spiking tool 616-ES Canvas bag	12.9 lb (5.86 kg)
<b>RPT1</b>	—	Replacement piercing tip	1 oz (28 kg)

**⚠ WARNING**  
**ELECTRIC SHOCK HAZARD**  
 This tool is not insulated. Use only certified, non-conductive hoses, dielectric fluids, and proper personal protective equipment when using this unit. Failure to do so could result in severe injury or death.





## SAFETYLINE DUCK BILL GROUNDING CLAMPS

1.1 IN (27.9 MM) AND 1.66 IN (42.2 MM)



767E-ES



768E-ES



760006E-ES

1.1 IN (27.9 MM) DUCKBILL CLAMPS										
Item #	Size in (mm)	Material	ASTM Grade/Class	Thread Type	Eye Screw/T Handle	Strain Relief?	Jaw Type	Main Line Range	Continuous Current (amps) 60 Hz	Weight ea. lb (kg)
767E-ES	1.13 in (28.7 mm)	Aluminum	3 / A	Threaded	Stainless steel eye screw	N	Smooth	795 MCM ACSR to #6 0.19 in to 1.13 in (4.8 mm to 28.7 mm) dia.	300 RMS amps, 60 Hz	1.4 lb (0.63 kg)
768E-ES	1.13 in (28.7 mm)	Aluminum	3 / A	Threaded	Stainless steel eye screw	N	Smooth			1.4 lb (0.63 kg)
1.63 IN (42 MM) DUCKBILL CLAMPS										
760006E-ES	1.63 in (41.4 mm)	Aluminum	5/ A	Threaded	Eye screw	N	Smooth	954 MCM ACSR to #6 0.19 in to 1.63 in (4.8 mm to 41 mm) dia.	400 RMS amps, 60 Hz	3 lb (1.36 kg)

# SAFETYLINE

## SAFETYLINE "C" TYPE GROUNDING CLAMPS

0.75 IN (19 MM)

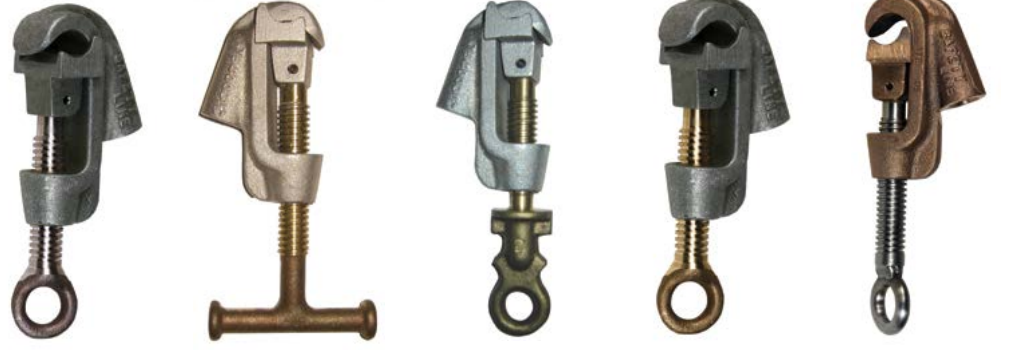

7640001E-ES 7640001TB-ES 764001PG-ES 7640001EB-ES 7640CMS1E-ES

0.75 IN (19 MM) C-CLAMPS										
Item #	Size in (mm)	Material	ASTM Grade/Class	Thread Type	Eye Screw/T-Handle	Strain Relief?	Jaw Type	Main Line Range	Continuous Current (amps) 60 hz	Weight ea. lb (kg)
7640001E-ES	0.75 in (19 mm)	Aluminum	5 / A	Threaded	Stainless steel eye screw	N	Smooth	2 Ø MCM ACSR to #6 0.19 in to 0.75 in (4.8 mm to 19 mm) dia.	400 RMS amps, 60 Hz	1 lb (0.45 kg)
7640001TB-ES	0.75 in (19 mm)	Aluminum	5 / A	Threaded	Bronze t-handle	N	Smooth			1 lb (0.45 kg)
764001PG-ES	0.75 in (19 mm)	Aluminum	5 / A	Threaded	Bronze posigrip	N	Smooth			1 lb (0.45 kg)
7640001EB-ES	0.75 in (19 mm)	Aluminum	5 / A	Threaded	Bronze eye screw	N	Smooth			1 lb (0.45 kg)
7640001CCE-ES	0.75 in (19 mm)	Aluminum	5 / A	Threaded	Stainless steel eye screw	N	Smooth, jaw milled flat			1 lb (0.45 kg)
7640CM1E-ES	0.75 in (19 mm)	Bronze	5 / A	Threaded	Stainless steel eye screw	N	Smooth			3 lb (1.46 kg)
76400S1E-ES	0.75 in (19 mm)	Aluminum	5 / B	Threaded	Stainless steel eye screw	N	Serrated			1 lb (0.45 kg)
7640CMS1E-ES	0.75 in (19 mm)	Bronze	5 / B	Threaded	Stainless steel eye screw	N	Serrated	3 lb (1.46 kg)		

## SAFETYLINE "C" TYPE GROUNDING CLAMPS

1.25 (31.75 MM) AND 1.5 IN (38 MM) SIZES



760001E-ES

1.25 IN (31.75 MM) C-CLAMPS										
Item #	Size in (mm)	Material	ASTM Grade/Class	Thread Type	Eye Screw/T-Handle	Strain Relief?	Jaw Type	Main Line Range	Continuous Current (amps) 60 hz	Weight ea. lb (kg)
760001E-ES	1.25 in (31.75 mm)	Aluminum	5 / A	Threaded	Stainless steel eye screw	N	Smooth	900 MCM ACSR to #6 0.19 in to 1.25 in (4.8 mm to 131.8 mm) dia.	400 RMS amps, 60 Hz	1 lb (0.45 kg)
760001RT-ES	1.25 in (31.75 mm)	Aluminum	5 / A	Threaded	Stainless steel removable T-handle	N	Smooth			1 lb (0.45 kg)
7600S1PSE-ES	1.25 in (31.75 mm)	Aluminum	5 / A	Threaded	Stainless steel eye w/ parking stand	N	Smooth			1.3 lb (0.6 kg)
760001CS-ES	1.25 in (31.75 mm)	Aluminum	5 / B	Threaded	Stainless steel eye w/ parking stand	N	Smooth			1.3 lb (0.6 kg)
7600S1E-ES	1.25 in (31.75 mm)	Aluminum	5 / B	Threaded	Stainless steel eye screw	N	Serrated			1 lb (0.45 kg)
7600S1T-ES	1.25 in (31.75 mm)	Aluminum	5 / B	Threaded	T-handle	N	Serrated			1 lb (0.45 kg)

## SAFETYLINE "C" TYPE GROUNDING CLAMPS

2.13 IN (54 MM) AND 2.5 IN (63.5 MM)



7512B-ES

2.13 IN (51 MM) C-CLAMP										
Item #	Size in (mm)	Material	ASTM Grade/Class	Thread Type	Eye Screw/T-Handle	Strain Relief?	Jaw Type	Main Line Range	Continuous Current (amps) 60 Hz	Weight ea. lb (kg)
76600S1E-ES	2.13 in (54 mm)	Aluminum	5 / B	Threaded	Stainless Steel eye	N	Serrated	3000 MCM ACSR to #6 0.25 in to 2.13 in (6.4 mm to 54 mm) dia.	400 RMS amps, 60 Hz	2 lb (0.91 kg)
76600S1PG-ES	2.13 in (54 mm)	Aluminum	5 / B	Threaded	Posigrip, stainless steel eye	N	Serrated			2 lb (0.91 kg)
2.5 IN (63.5 MM) C-CLAMP										
7512B-ES	2.5 in (63.5 mm)	Aluminum	5 / A	Pin/thread	Stainless steel bayonet	N	Smooth	2 in I.P.S. to #6 0.5 in to 2.5 in (12.7 mm to 63.5 mm) dia.	400 RMS amps, 60 Hz	4 lb (1.8 kg)

## SAFETYLINE FLAT JAW GROUNDING CLAMPS

1.4 IN (35.6 MM) AND 1.5 IN (38 MM) SIZES

Flat jaw grounding clamps are available with either a large "T" handle or with an eye for clampstick application. The handles and eyes are designed so that the cable will not interfere with the torquing of the clamp. The set screw that secures the clamp to a flat surface is located on the movable jaw on all designs. When tightened, the set screw forces the fixed jaw of the clamp firmly against the flat ensuring a consistent low resistance current path directly through the body of the clamp to the cable connection. With other designs having a set screw on the fixed jaw, current is required to flow through mechanical connections between the movable jaw, the eye screw and the body of the clamp before passing to the cable connection.

1.4 IN (35.6 MM) FLAT JAW CLAMPS										
Item #	Size in (mm)	Material	ASTM Grade/Class	Thread Type	Eye Screw/T-Handle	Strain Relief?	Jaw Type	Main Line Range	Continuous Current (amps) 60 Hz	Weight ea. lb (kg)
760002TLA-ES	1.4 in (35.6 mm)	Aluminum	5 / B	Pin	Stainless steel eye screw	N	Serrated	0.19 in to 1.4 in (4.8 mm to 35.6 mm) dia.	400 RMS amps, 60 Hz	1 lb (0.45 kg)
1.5 IN (38 MM) FLAT JAW CLAMPS										
760CM3T-ES	1.5 in (38 mm)	Aluminum	5 / B	Threaded	Stainless steel t-handle	N	Serrated	0.19 in to 1.4 in (4.8 mm to 35.6 mm) dia.	400 RMS amps, 60 Hz	3.2 lb (1.4 kg)
760003E-ES	1.5 in (38 mm)	Aluminum	5 / B	Threaded	Stainless steel eye screw	N	Serrated			1.2 lb (0.5 kg)
760003T-ES	1.5 in (38 mm)	Aluminum	5 / B	Threaded	Stainless steel t-handle	N	Serrated			1.2 lb (0.5 kg)

## SAFETYLINE ALL ANGLE CLAMPS

2.5 IN (63.5 MM) AND 4 IN (101.6 MM) SIZES



73025T-ES

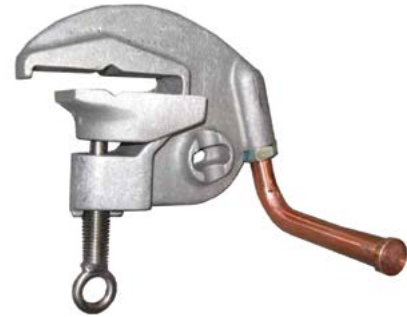

7316E-ES

2.5 IN (63.5 MM) ALL ANGLE CLAMPS										
Item #	Size in (mm)	Material	ASTM Grade/Class	Thread Type	Eye Screw/T-Handle	Strain Relief?	Jaw Type	Main Line Range	Continuous Current (amps) 60 Hz	Weight ea. lb (kg)
73025T-ES	2.5 in (63.5 mm)	Aluminum	5 / A	Threaded	Stainless steel eye screw	N	Smooth	0.3 in to 1.6 in (8 mm to 41 mm) dia.	400 RMS amps, 60 Hz	2.5 lb (1.1 kg)
4 IN (101.6 MM) ALL ANGLE CLAMPS										
7304T-ES	4 in (101.6 mm)	Aluminum	5 / A	Threaded	Stainless steel T-handle	N	Smooth	0.25 in to 0.94 in (6 mm to 24 mm) dia.	400 RMS amps, 60 Hz	3.3 lb (1.5 kg)
7316E-ES	4 in (101.6 mm)	Aluminum	3 / B	Exceeds Grade 5	Stainless steel eye screw	—	Smooth	—	49KA for 15 cycles with X/R=25	
7304DE-ES	4 in (101.6 mm)	Aluminum	5 / B	Exceeds Grade 5	Stainless steel eye screw	—	Smooth	—		

## SAFETYLINE SUBSTATION BUS CLAMPS

Cutout clamps are applied with a clampstick into the bottom hinge contact of a cutout. This clamp can be used as part of a ground assembly or by using a contact stud using a standard grounding assembly with “C” clamps from the stud to ground.



7310E-ES



R101DE-ES

ALUMINUM SUBSTATION CLAMP										
Item #	Size in (mm)	Material	ASTM Grade/Class	Thread Type	Eye Screw/T-Handle	Strain Relief?	Jaw Type	Main Line Range	Continuous Current (amps) 60 Hz	Weight ea. lb (kg)
7310E-ES	4.5 in (114.3 mm)	Aluminum	5 / A	Pin	Stainless steel eye screw	N	Smooth	0.5 in to 4.5 in (12.7 mm to 114 mm) dia	400 RMS amps, 60 Hz	4 lb (1.8 kg)
R101DE-ES	6 in (152.4 mm)	Aluminum	5 / B	Threaded	Stainless steel eye screw	N	Smooth	1 Ø I.P.S., 0.5 in to 6 in (12.7 mm to 152 mm) dia.		4 lb (1.8 kg)

## SAFETYLINE SUBSTATION BUS CLAMPS

### 4.4 IN (111.8 MM)



7541E-ES

7541T-ES

4.4 IN (111.8 MM) ALUMINUM SUBSTATION CLAMP										
Item #	Size in (mm)	Material	ASTM Grade/Class	Thread Type	Eye Screw/T-Handle	Strain Relief?	Jaw Type	Main Line Range	Continuous Current (amps) 60 Hz	Weight ea. lb (kg)
7541E-ES	4.4 in (111.8 mm)	Aluminum	5 / B	Threaded	Stainless steel eye screw	N	Serrated	0.31 in to 4.25 in (7.9 mm to 112 mm) dia.	400 RMS amps, 60 Hz	2 lb (0.9 kg)
7541PG-ES	4.4 in (111.8 mm)	Aluminum	5 / B	Threaded	Stainless steel with posigrip	N	Serrated			2 lb (0.9 kg)
7541T-ES	4.4 in (111.8 mm)	Aluminum	5 / B	Threaded	Stainless steel with T-handle	N	Serrated			2 lb (0.9 kg)
7542B-ES	4.4 in (111.8 mm)	Aluminum	5 / B	Pin	Stainless steel bayonet	N	Serrated			2 lb (0.9 kg)
7542E-ES	4.4 in (111.8 mm)	Aluminum	5 / B	Pin	Stainless steel eye screw	N	Serrated			

## SAFETYLINE BUS BAR ALLIGATOR CLAMPS

### 0.5 IN (12.7 MM)



7575FE-ES

7575FTE-ES

0.5 IN (12.7 MM) BRONZE ALLIGATOR CLAMPS										
Item #	Size in (mm)	Material	ASTM Grade/Class	Thread Type	Eye Screw/T-Handle	Strain Relief?	Jaw Type	Main Line Range	Continuous Current (amps) 60 Hz	Weight ea. lb (kg)
7575FE-ES	0.5 in (12.7 mm)	Bronze	2 / A	Threaded	Stainless steel eye screw	N	Smooth	0.0234 in to 0.05 in (6 mm to 12.7 mm) dia.	250 RMS amps, 60 Hz	2 lb (0.9 kg)
7575FTE-ES	0.5 in (12.7 mm)	Bronze	2 / B	Threaded	Stainless steel eye screw	N	Serrated			2 lb (0.9 kg)
7575FTGA-ES	0.5 in (12.7 mm)	Bronze	2 / B	Threaded	Stainless steel grip-all	N	Serrated			2 lb (0.9 kg)

## SAFETYLINE SPECIALTY CLAMPS

The running power rail ground set is made up of 7561A power rail clamp and 7560 running rail clamp connected with three feet (91.4 cm) of 4/0 PVC-jacketed copper cable. Set includes one 10024BC, 1 in x 24 in (2.5 x 61 cm) fiberglass handle with bayonet to operate the power rail clamp.

The ball and socket grounding system has a lightweight compact design and allows for variable angle accessibility. These clamps are made from bronze alloy and have a socket size of 1 in (25.4 mm) with a threaded bore boss of 5/8 in-11 UNC. There are fixed grounding points on the socket clamp.



78000-ES



7561A-ES



7560-ES

### RAIL CLAMPS

Item #	Size in (mm)	Material	ASTM Grade/Class	Thread Type	Eye Screw/T-Handle	Strain Relief?	Jaw Type	Main Line Range	Continuous Current (amps) 60 Hz	Weight ea. lb (kg)
78000-ES	1.63 in (41.4 mm)	Aluminum	3 / A	Pin/ threaded	Stainless steel eye		Smooth	0.125 in to 1.63 in (3.18 mm to 41.4 mm)	300 RMS Amps, 60 Hz	10 lb (4.5 kg)
7561A-ES	4 in (101.6 mm)	Aluminum	5 / B	Pin/ threaded	Stainless steel bayonet		Serrated	0 in to 4 in (0 mm to 101.6 mm)		7 lb (3.2 kg)
75675475-ES	5.75 in (146 mm)	Aluminum	5/B	Pin	Stainless steel toggle handle	N	Serrated	5 in to 5.75 in (12.7 mm to 146 mm)	400 RMS amps, 60 Hz	5 lb (2.7 kg)
7560-ES	5.75 in (146 mm)	Aluminum	5 / B	Pin	Stainless steel toggle handle	N	Serrated	5 in to 5.75 in (12.7 mm to 146 mm)		5 lb (2.7 kg)

## SAFETYLINE BALL & SOCKET SYSTEM



7542CM1EB-ES

### SOCKET CLAMPS

Item #	Description	Material	ASTM Grade/Class	Thread Type	Fits Ball Studs:	Eye Screw/T-Handle	Strain Relief?	Continuous Current (amps) 60 Hz	Weight ea. lb (kg)
7542CM1EB-ES	Bronze socket clamp	Bronze	5 / A	Threaded	1 in (25.4 mm)	Eye screw	N	400 RMS amps, 60 Hz	1.5 lb (0.68 kg)

## SAFETYLINE BALL STUDS

The ball studs and the offset Nema pad ball studs are made from tin-plated copper alloy or copper. They each have a 1 in (25.4 mm) diameter ball. Recommended installation torque of 300 in. lbs. The short stud is used conventionally. The long stud can also be used as the grounding point for "C" or Duck bill clamps that have a jaw width of 2.75 in (69.85 mm) or less. The offset Nema pad ball stud has the standard Nema bolt hole spacing and also comes in both long and short lengths.

The ball stud cover is made from orange SALCOR® which allows for multiple angle application when installed using a clampstick.



754212134T-ES



754212334T-ES

BALL STUDS						
Item #	Description	ASTM Grade/Class	Overall Length in (mm)	Thread Dimensions in (mm)	Shank Dimensions in (mm)	Weight ea. lb (kg)
7542001BSF-ES	Female ball stud	2	2.5 in (63.5 mm)	1.5 in (38 mm)	1 in (25.4 mm)	14 lb (6.3 kg)
7542123BS-ES	Straight ball stud, copper	3	5.12 in (130 mm)	2.1 in (54 mm)	3 in (76 mm)	0.8 lb (0.36 kg)
754212334T-ES	Ball stud, tin-plated copper	5H	6.72 in (171 mm)	2.5 in (63 mm)	2.88 in (73 mm)	
754212534T-ES	Ball stud, tin-plated copper	5H	9.34 in (237 mm)	2.5 in (63 mm)	5.5 in (140 mm)	
754212134T-ES	Straight ball stud, copper	5H		2.2 in (57 mm)	1 in (25 mm)	
7542121BS-ES	Ball stud, copper	5	4.7 in (119 mm)	2.45 in (62 mm)	2.25 in (57 mm)	0.56 (0.25 kg)
7542125BST-ES	Straight ball stud, tin-plated copper	5	7.62 in (193.5 mm)	2.1 in (54 mm)	5.5 in (140 mm)	1 lb (0.45 kg)
7542905BST-ES	90° Ball stud, tin-plated copper	3	7.62 in (193.5 mm)	2.1 in (54 mm)	5.5 (140 mm)	1.25 lb (0.57 kg)

## SAFETYLINE THREADED & PIN FERRULES

For threaded ferrules (terminals) the recommended torque applied during installation of jam nut for threaded ferrules is 20 ft.-lb. These threaded ferrules include one brass jam nut and one lock washer. For pin terminals the recommended torque applied during installation of pin ferrule eye bolts is 28 ft.-lb.

Grounding cables are made with extra flexible strand of soft drawn #30 AWG .01 in (0.25 mm) copper and are available in three different jackets.



7600011CT42-ES



7600011PT42-ES

COPPER THREADED UNSHROUDED FERRULES								
Item #	Material	Shrouded/Unshrouded	Cable Size	Length in (mm)	Strand Dia. Codes T & B	Jacket Die Codes T & B	Burndy Die Number	Weight Ea. Pair lb (kg)
98132025-ES	Copper	Unshrouded	4/0		T&B 62			
COPPER THREADED SHROUDED FERRULES								
7600011CT40-ES	Copper	Shrouded	#2		U27RT	U27ART		
7600011CT42-ES	Copper	Shrouded	2/0		T&B 66	B75-AH		
COPPER PIN SHROUDED FERRULES								
Item #	Material	Shrouded/Unshrouded	Cable Size	Length in (mm)	Strand Dia. Codes T & B	Jacket Die Codes T & B	Burndy Die Number	Weight Ea. Pair lb (kg)
7600011PT41-ES	Copper	Shrouded	1/0	5.75 in (146 mm)	T&B 66	B75-AH		
7600011PT42-ES	Copper	Shrouded	2/0	5.75 in (146 mm)	T&B 66	B75-AH		
COPPER, TIN PLATED THREADED SHROUDED FERRULE								
7600011CT41T-ES	Copper Tin-plated	Shrouded	1/0		T&B 66	B75-AH		
7600011CT42T-ES	Copper Tin-plated	Shrouded	2/0		T&B 66	B75-AH		
7600011CT40T-ES	Copper Tin-plated	Shrouded	#2		U27RT	U27ART		
COPPER THREADED SHROUDED FERRULES								
98132023T-ES	Copper Tin-plated	Unshrouded	1/0	3 in (76.2 mm)	U243			

## SAFETYLINE GROUNDING SETS

### DEAD FRONT GROUNDING JUMPERS & ELBOWS

Both 15 kV and 25 kV elbows are available with connectors for 1/0 or 2/0 cable. Assembled sets for 15 kV and 25 kV are available for single phase or three-phase grounding requirements. The fault duty rating for 200 amp grounding elbows is 10 kA for 10 cycles per IEEE 386. Standard three-phase sets have a 4 ft (1.2 m) tail connecting to a 2374 four-wire connector with 2 ft (0.6 m) leads for the elbows. Sets can be factory assembled to customer specifications.

GROUND ELBOWS		
Item #	Description	Weight ea. lb (kg)
<b>764015GE-ES</b>	15kV Ground elbow dead break	1 lb (0.45 kg)
<b>764150015LSO-ES</b>	15kV Ground bushing load break	2 lb (0.9 kg)
<b>764150025LSO-ES</b>	25kV Ground bushing load break	4 lb (1.81 kg)
200 AMP ELBOW CONNECTOR TOOLS		
<b>9202Q-ES</b>	Elbow connector tool – quick change fitting	2 lb (0.9 kg)
<b>12548HH-ES</b>	Insulated stick for 6 ft (1.8 m) remover	3 lb (1.36 kg)
600 AMP ELBOW CONNECTOR TOOLS		
<b>9206Q-ES</b>	Elbow connector tool – quick change fitting	2 lb (0.9 kg)
<b>9206GAS-ES</b>	Elbow connector tool	2 lb (0.9 kg)

Optional ground set label available upon request when ordering.

## SAFETYLINE GROUNDED BUSHING SETS & ELBOW GROUNDING SETS

### 200 AMP

The single grounded bushing set is a single lead made from 6 ft (1.83 m) of 1/0 cable. The bushing set consists of three bushing assemblies connected together with 3-foot (0.92 m) leads to a common connection, and 10 ft (3.05 m) from common connection to ground. The conductor is made of 1/0 clear jacketed copper stranded cable. The ground clamp (7640001E) can be applied with a clampstick. Sets come complete with bag; single leads do not. All sets are rated for 10 kA for 10 cycles. Other lengths and configurations are available.

Ground bushings with connections (parking stands for 'J' boxes or padmounts) provide a safe, convenient ground for elbows and a "positive" test to ensure a de-energized elbow.

The elbow grounding set includes a single lead made from 6 ft (1.83 m) of 1/0 cable. This set consists of three elbow assemblies connected together with 3-foot (0.92 m) leads to a common connection, and 10-feet (3.05 m) from a common connection to ground. The conductor is made of 1/0 clear jacketed copper stranded cable. A ground clamp (7640001E) can be applied with a clampstick. Sets are rated for a maximum fault current of 10,000 amps for 10 cycles. Sets come complete with bag; single leads do not. Other lengths and configurations are available.



EB1021015LB-ES



ES1021015LB-ES

200 AMP GROUNDED BUSHING SETS		
Item #	Description	Weight lb (kg)
<b>EB1021015LB-ES</b>	15 kV Grounding bushing cluster	9 lb (4.1 kg)
<b>EB1021025LB-ES</b>	25 kV Grounding bushing cluster	23 lb (10.4 kg)
<b>EB100615LB-ES</b>	15 kV Grounded bushing, single	9 lb (4.1 kg)
200 AMP ELBOW GROUNDING SETS		
<b>ES100615-ES</b>	15 kV Elbow grounding set, dead break, single	8 lb (3.63 kg)
<b>ES1021015LB-ES</b>	25 kV Elbow grounding set, load break, cluster	22 lb (9.98 kg)
<b>ES100625LB-ES</b>	25 kV/35 kV Elbow grounding set, load break, single	10 lb (4.53 kg)
<b>ES100615LB-ES</b>	15 kV Elbow grounding set, load break, single	9 lb (4.08 kg)
UNDERGROUND GROUNDING ASSEMBLY		
<b>ES10Y615LB-ES</b>	15 kV Underground grounding assembly, single	2 lb (0.91 lb)
<b>ES1Y21015LB-ES</b>	15 kV Underground grounding assembly, cluster	22 lb (9.98 kg)
<b>S10Y625LB-ES</b>	25 kV Underground grounding assembly, single	10 lb (4.53 kg)

Optional ground set label available upon request when ordering.



## SAFETYLINE GROUNDING ASSEMBLIES

### SINGLE POINT DISTRIBUTION GROUNDING SET & BALL SOCKET FOUR-WAY CONNECTOR SETS

Ball socket four-way connector sets are designed for variable angle accessibility, three-phase grounding. It is supplied with three-foot leads and six feet of cable from a common connection to ground. Upper heads are ball socket clamps (7542CM1E). Lower ground head is a standard "C" type ground head (760001E) with a range of #6 to 1-1/4 inch (32 mm). Ball studs needed but not included.

BALL SOCKET CLUSTER SETS			
Item #	Cable Size	ASTM Grade	Weight lb (kg)
75420010236-ES	(3) 7542CM1E-ES Ball socket clamp	1	9 lb (4.08 kg)
	(3) 3 ft (0.9 m) 760001E-ES C-clamp #2 cable		
	(1) 6 ft (1.8 m) 760001E-ES C-clamp #2 cable		
75420011036-ES	(3) 7542CM1E-ES Ball socket clamp	2	12 lb (5.44 kg)
	(3) 3 ft (0.9 m) 760001E-ES C-clamp 1/0 cable		
	(1) 6 ft (1.8 m) 760001E-ES C-clamp 1/0 cable		
75420012036-ES	(3) 7542CM1E-ES Ball socket clamp	3	14 lb (6.35 kg)
	(3) 3 ft (0.9 m) 760001E-ES C-clamp 2/0 cable		
	(1) 6 ft (1.8 m) 760001E-ES C-clamp 2/0 cable		

Optional ground set label available upon request when ordering.



75420010236-ES

## SAFETYLINE GROUNDING SETS

### FOUR-WAY CONNECTOR SET, FOUR-WAY CONNECTOR AND SQUEEZE-ONS

The four-way connector sets are made with #2 clear-jacketed, extra flexible cable, three 8 ft (2.44 m) leads from the heads to the common connection and one 50 ft (15.25 m) lead from the common connection to the ground connection. The grounding four-way connector set has a fixture to raise and lower the set which can be easily tied onto the pole. The 752076 grounding four-way connector set is also supplied with 3 fiberglass handles (10078BC) and a bag. The 752576 grounding four way connector set requires a clampstick. Sets come with bags. Other lengths and configurations available. Meets ASTM F 855 Grade 1 specifications. Maximum fault duty is 14.5 kA for 15 cycles.

Four-way connectors are used to create a common connection between the conductor leads and the ground lead of a ground set.

FOUR-WAY CONNECTOR SETS			
Item #	Description	ASTM Grade	Weight Ea lb (kg)
752076-ES	(4) 1.25 in (31.75 mm) 760001E-ES Aluminum C-clamp with bayonet	1	32 lb (14.5 kg)
	(4) 760001CT40-ES Ferrule		
	(3) 8 ft (2.4 m) 7340XF #2 Clear cable		
	(3) 8 ft (2.4 m) 7340XF #2 Clear cable		
	(1) 50 ft (15.2 m) 7340XF #2 Clear cable		
752576-ES	(2) 6 in (2.4 mm) 766HS1052-ES Clear heat shrink	1	39 lb (17.9 kg)
	(4) 1.25 in (31.75 mm) 760001E-ES Aluminum C-clamp with eye screw		
	(4) 760001CT40-ES Ferrule		
	(3) 8 ft (2.4 m) 7340XF #2 Clear cable		
	(3) 8 ft (2.4 m) 7340XF #2 Clear cable		
	(1) 50 ft (15.2 m) 7340XF #2 Clear cable		
	(2) 6 in (2.4 mm) 766HS1052-ES Clear heat shrink		

GROUND SET ACCESSORIES			
Item #	Description	Max. Opening in (cm)	Weight Ea lb (kg)
76630882-ES	Squeeze-on for #2 cable	1	0.5 lb (0.23 kg)
76630782-ES	Squeeze-on for 1/0 to 4/0 cable	2	0.5 lb (0.23 kg)
CA36-ES	Aluminum four-way cluster block	1	2 lb (0.91 kg)
CB36-ES	Copper four-way cluster block	1	3 lb (1.36 kg)

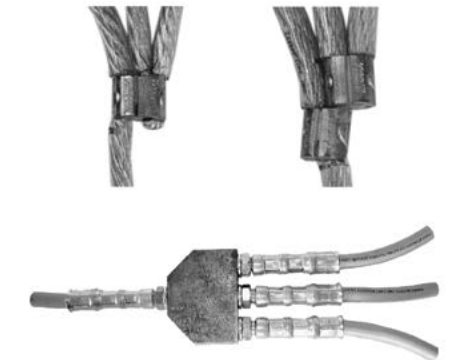

752576-ES



76630882-ES



CB36-ES

## SAFETYLINE GROUNDING SETS

### QUICK GRIP GROUND CLAMPS & GROUNDING SETS

Quick grip clamps are specifically designed and ideally suited for temporary grounding where spacing and orientation of components limit the use of traditional ground clamps. The quick grip ground clamp is available with a grip-all eye or a bayonet fitting for installation with a live line tool.

- Available in both the traditional style (VG01) and a hotstick operated version (VG01GA and VG01B)
- Available in a single lead ground jumper or grounding set with 1, 3 or 4 leads for grounding of single or three-phase secondary terminals
- Fitted with a copper overlay, riveted to the stationary jaw and connected to a grounding jumper with a one hole NE MA connector to assure a low resistance connection
- The grounding set connection is made using standard copper compression connectors and all connections are covered with a heat-shrink tube to reduce fatigue at stress points
- The locking jaw pliers are equally suited for flat or rounded terminals. Optional flat jaw available.



VG01GA-ES



VG11034-ES

## SAFETYLINE GROUNDING SETS

### INDUSTRIAL GROUND FOUR-WAY GROUND CLUSTER

The industrial ground Set consists of three upper ground heads, one lower head, visible trifurcation, 6 ft (1.83 m) leads to common connections and a 20 ft (6 m) lead from common to ground connection. All ground heads (7541B and 7541T) will accept 4 in x 4 in (10.2 cm x 10.2 cm) copper or aluminum bus configurations.

Also includes a bag for installation at the main disconnect point. The 7551 includes a 1 ft (0.3 m) fiberglass handle (10012BC) for installing upper heads.

*NOTE: 8106C clampstick (not included) must be used to apply 7551GA grounds. Other lengths available. Conductor size is 2/0 copper. Meets ASTM F-855 grade 3 specifications. Maximum fault duty is 27kA for 15 cycles.*

Lightweight industrial ground sets are designed for smaller conductor size applications. Clamps used include screws with eyes (GA attachments) for use with a clampstick. A #2 extra flexible copper ground cable is used throughout. The 75FGT0266 has 6 ft (1.83 m) leads to the common connection and a 6 ft lead from the common connection to ground. The 7640244GA uses 4 ft (1.22 m) leads throughout. Sets include a bag. Other lengths and configurations are available.



7551-ES

### LOCKING PLIERS

Item #	Description	ASTM Grade	Clamp Openings in (mm)	Cable Length ft. (m)	Weight lb (kg)
VG01-ES	1.5 in (38.1 mm) Copper locking pliers with vice grip	3	0.125 in to 1.5 in (3.175 mm to 38.1 mm)	N/A	1.5 lb (0.68 kg)
VG01-ES	1.5 in (38.1 mm) Copper locking pliers with flat jaw	3	0.125 in to 1.5 in (3.175 mm to 38.1 mm)	N/A	1.6 lb (0.73 kg)
VG01GA-ES	1.5 in (38.1 mm) Copper locking pliers with grip-all	3	0.125 in to 1.5 in (3.175 mm to 38.1 mm)	N/A	1.6 lb (0.73 kg)

### GROUNDING SETS

VG01013-ES	Single lead, 1/0 x 3 ft (0.9 m) with VG01-ES	3	0.125 in to 1.5 in (3.175 mm to 38.1 mm)	3 ft (0.9 m)	3.6 lb (1.63 kg)
VG01033-ES	3 Lead, 1/0 x 3 ft (0.9 m) with VG01-ES	3	0.125 in to 1.5 in (3.175 mm to 38.1 mm)	9 ft (2.7 m)	10.5 lb (4.77 kg)
VG01034-ES	4 Lead, 1/0 x 3 ft (0.9 m) with VG01-ES	3	0.125 in to 1.5 in (3.175 mm to 38.1 mm)	12 ft (3.7 m)	13.2 lb (5.99 kg)
VG01034-ES	4 Lead, 1/0 x 3 ft (0.9 m) with VG01-ES	3	0.125 in to 1.5 in (3.175 mm to 38.1 mm)	12 ft (3.7 m)	13.2 lb (5.99 kg)
VG11034-ES	4 Lead, 1/0 x 3 ft (0.9 m) with VG01-ES	3	0.125 in to 1.5 in (3.175 mm to 38.1 mm)	12 ft (3.7 m)	13.6 lb (6.17 kg)
VG11034-ES	4 Lead, 1/0 x 3 ft (0.9 m) with VG01-ES	3	0.125 in to 1.5 in (3.175 mm to 38.1 mm)	12 ft (3.7 m)	13.6 lb (6.17 kg)

Optional ground set label available upon request when ordering.

### INDUSTRIAL GROUND CLUSTER

Item #	Description	ASTM Grade	Weight Ea lb (kg)
7551-ES	(3) 7541B-ES C Ground clamp with bayonet (4) 7600011CT42-ES 2/0 Threaded copper ferrule (2) 6 ft (1.8 m) 7342XF 2/0 Clear cable (1) 26 ft (7.9 m) 7342XF 2/0 Clear cable 7541T-ES Ground clamp with T-handle (2) YH2929-ES Cable squeeze-on (1) 8 ft (2.4 m) 766HS1052-ES Black heat shrink	1	35 lb (15.8 kg)
7551GA	(3) 7541E-ES C Ground clamp with eye screw (4) 7600011CT42-ES 2/0 Threaded copper ferrule (3) 6 ft (1.8 m) 7342XF 2/0 Clear cable (1) 20 ft (6.1 m) 7342XF 2/0 Clear cable 7541T-ES Ground clamp with T-handle (2) YH2929-ES Cable squeeze-on (1) 2 ft (0.6 m) 766HS1052-ES Heat shrink	3	35 lb (15.8 kg)

## SAFETYLINE URD ASSEMBLY, NEUTRAL JUMPER ASSEMBLY & UNDERGROUND DEAD BREAK SET

The concentric neutral jumper Assembly is used for bonding purposes on non-jacketed cable. It is usually installed across a portion of cable to be cut, repaired or spliced. The assembly is left in place until the concentric neutral is spliced. As a safety precaution, follow all of your organization’s applicable rules and/or policies pertaining to faulted cable, spiking and grounding.

Made with two ground clamps and 4 ft (1.22 m) of 1/0 clear jacketed extra flexible copper cable, the concentric neutral ground clamp is spring pressured. The assemblies have a continuous current rating of 250 amps and fault rated to ASTM Grade 1, 14 KA for 15 cycles. Other lengths are available. Bag not included.

The components of the underground dead break ground set provide safe and simple grounding methods on padmount transformers or any related UR D equipment. These grounds can be ordered in complete sets or individual components. The jumpers are made with 6 ft (1.83m) lengths of #2, clear-jacketed, extra flexible cable. Clamps (7640001E) supplied include an eye for a grip-all insulating stick application.

The URD Grounding Assembly is used for underground personal protective grounding elbow used for grounding pad-mounted equipment, switches and transformers when performing de-energized maintenance on UR D distribution systems, and draining DC capacitive charges from de-energized UR D cables.

CONCENTRIC NEUTRAL JUMPER ASSEMBLY			
Item #	Description	For Cable Diameter in (mm)	Weight Ea lb (kg)
7603-ES	(2) 7603C-ES Ground clamp with wing nut (1) 4 ft (1.2 m) 7603F-ES 2/0 Cable (2) 7603A1-ES 2/0 Aluminum threaded (1) 7603S-ES Compression Spring	0.75 in to 2 in (19 mm to 51 mm)	12 lb (5.44 kg)
7603GA-ES	(2) 7603CGA-ES Ground clamp with grip all (1) 4 ft (1.2 m) 7341XF-ES 1/0 Clear cable (2) 7600011CT41-ES 1/0 Copper shrouded ferrule	0.75 in to 2 in (19 mm to 51 mm)	12 lb (5.44 kg)
15 KV GROUND DEAD BREAK GROUND SET			
764156STGESO-ES	(3) 6ft (1.8 m) 764156234H-ES #2 Cable with 2 C-clamp (3) 764015GE-ES 15kV Ground elbow (3) 764015SO-ES 15kV Ground standoff with spring bail (3) 764000ST-ES Ground stud for low profile transformer (1) B1715-ES Protective bag	—	21 lb (9.2 kg)

Optional ground set label available upon request when ordering.



7603-ES



764156STGESO-ES

## SAFETYLINE ADAPTERS & TRUCK GROUNDING REEL

The “T” handle adapter allows the user to quickly and easily change an eye screw into a “T” handle screw.

Adapters are used on any pin type ground clamps. Meets ASTM F-855 Grade 5 specifications. Maximum fault duty is 43 kA for 15 cycles.

ADAPTERS		
Item #	Description	Weight Ea lb (kg)
7300ABC-ES	Pin to threaded adapter	0.5 lb (0.2 kg)
7310G-ES	Eye bolt assembly	0.5 lb (0.2 kg)
300AET-ES	Pin to threaded adapter	0.5 lb (0.2 kg)
"T" HANDLE ADAPTER		
760001HDL-ES	"T" handle adapter	0.5 lb (0.2 kg)

## SAFETYLINE GROUNDING ACCESSORIES

Truck grounding kit contains 2/0 cable, 2 feet (0.6 m) long, with a chassis/frame attachment on one end and a grounding stud on the other for Cat. No. 7542TGK. Brings body and chassis to the same ground potential. Other lengths are available. Meets ASTM F-855 Grade 3 specifications.

The pole band is lightweight and easy to install. It is a required component of equipotential zone grounding systems.

TRUCK GROUNDING KIT		
Item #	Description	Weight Ea lb (kg)
7542TGK-ES	Truck grounding kit with stud	2 lb (0.91 kg)

POLE BAND				
Item #	Description	Fault Duty 15 Cycles	Grade	Weight Ea. lb (kg)
760045PB-ES	Copper bar	43 kA	5	5 lb (2.27 kg)

## SAFETYLINE UNDERGROUND GROUNDING STUDS

The 1712 and 1725 grounding stud series are used for grounding when the fault duty on the 600 amp deadbreak elbow/ "T" body exceeds the rating of a 200 amp grounding elbow, as rated by IEEE 386 at 10kA for 10 cycles. Grounding studs consist of a 10 ft conductor stud with male or female threads for replacing 200 amp bushing wells and/or insulating plugs and a ground clamp bar for use with regular grounding jumper assemblies. After the cable has been proven de-energized, the stud is installed and a ground is applied.

The 1725001 grounding stud is made of 7/8 in diameter copper with a 5/8-11 female thread on one end and a 1in (2.5 cm) hex drive on the other end. This stud is fitted with a tapered guide and a 3/8 in diameter copper cross bar perch used for installing the ground. A socket drive is used for installation. For application, use catalog number 5900CS captured socket.

The 17250003, 17250004 and 17250005 are steel grounding plugs and studs with one 5/8 in diameter perch. The perch has a sturdy lip to ensure clamp contact during faults. These models are supplied with grip-all attachments for application with insulated clampstick tools and connectors. These studs are used for grounding equipment such as non load-break connectors or power distribution connectors.

The 1735 grounding stud is made of 7/8 in diameter copper with a 5/8-11 female thread on one end and a 1in (2.5 cm) hex drive on the other end for application with a socket drive. The cross bar perch is 3/4 in diameter copper, providing heavy duty service. This ground plug also comes equipped with a tapered guide and the yellow protective cap.

### UNDER GROUND GROUNDING STUDS

Item #	Description	Threads	Material (Stud)	ASTM F855		Weight Ea. lb (kg)
				Grade	Fault Duty	
<b>1725001-ES</b>	Copper electrode, female, hex drive, with guide	5/8-11 (F)	Cu	1	17 kA	2.2 lb (1 kg)
<b>17250003-ES</b>	Steel electrode, male, grip-all, with guide	5/8-11 (M)	Steel	3	27 kA	2 lb (0.9 kg)
<b>17250004-ES</b>	Steel electrode, female, grip-all, with guide	5/8-11 (F)	Steel	3	27 kA	2 lb (0.9 kg)
<b>17250005-ES</b>	Steel electrode, male, grip-all	3/4-10 (M)	Steel	3	27 kA	1.8 lb (0.8 kg)
<b>1735-ES</b>	Copper electrode, female, hex drive, with guide	5/8-11 (F)	Cu	4	35 kA	3.5 lb (1.6 kg)
<b>5900CS-ES</b>	Captured socket for 1725001 and 1735	—	—	—	—	—

## SAFETYLINE UNDERGROUND TOOLS & GROUND ADAPTER DEVICE KIT

The underground spanner wrench is designed for installing and removing the connector bushing, and reducing bushing inserts. Can be used when the conductor is de-energized, but not grounded. The tool is used one way for installation, and turned over for removal. A universal toggle and spring is used with this tool and should be ordered separately (5900Q).

Weight: 1 lb (0.45 kg).

The plug installing tool is used to install or remove 600 amp reducing plugs.

Weight: 2 lbs (0.91 kg).

The ground adapter device kit enables application of personal grounds up to a 600 amp separable pre-molded component system when used with a clampstick.

### TOOLS

Item #	Description
<b>1720-ES</b>	Underground spanner wrench for 600 amp connector
<b>172300-ES</b>	Quick change plug installing tool
GROUND ADAPTER DEVICE KIT	
<b>76174459-ES</b>	(1) 44C-ES Ratchet wrench (1) 5900Q-ES Universal toggle and spring (1) 1 in (25.4 mm) 5900CS-ES Socket with Friction ball (1) 9206GAS-ES Elbow connector tool with inserts (3) 1725001-ES Underground ground stud (1) B1715-ES Bag

## SAFETYLINE HAND OPERATED GROUND SPIKE & HYDRAULIC CUTTER SPIKE

### HAND OPERATED GROUND SPIKE: SPIKE DEPTH 1.75 IN (44,45 MM), CONDUCT OR MIN. 1 IN (25.4 MM)- MAX. 3.5 IN (88,9 MM)

Item #	Description	Cable Assembly		ASTM F855		Weight lb (kg)
		Cable	Clamp Item #	Grade	Fault Duty	
<b>1712CS-ES</b>	3 ft (0.91 m) FG Handle, Toggle /GA	1/0 Clear	760001E	1	14.5 kA	15 lb (6.8 kg)
<b>1712U-ES</b>	Spike point with U	1/0 Clear	760001E	1	14.5 kA	10 lb (4.5 kg)
<b>1712GA-ES</b>	Spike point with eye with GA	1/0 Clear	760001E	1	14.5 kA	10 lb (4.5 kg)

### HYDRAULIC CUTTER SPIKE: CLAMP CAT. NO. 760001E, CONDUCT OR MIN. 0 IN - MAX. 3.5 IN (88.9 MM)

Item #	Description	Pump		Cable Assembly Cable	ASTM F855		Weight lb (kg)
		MDL	P.S.I		Grade	Fault Duty	
<b>17150050-ES</b>	Huskie head	N/A	N/A	#2 Clear	1	14.5 kA	23 lb (10.5 kg)
<b>17150060EPP</b>	Spike point with eye - "T" screw	1715P392	10,000	#2 Clear	1	14.5 kA	52 lb (23.6 kg)



# FIBERGLASS HOTSTICKS

## Standard Specifications

There are a variety of Fiberglass Reinforced Plastic (FRP) constructions used for hotsticks. Included are foam filled tubular sticks used for all products requiring solid construction. All Salisbury fiberglass sticks meet ASTM F711 Standard Specifications for FRP and tubes used in live line tools and IEC 855.

Foam filled hotsticks are manufactured using the pultrusion process. This method incorporates fiberglass reinforcement in a resin matrix which creates a moisture resistant laminate with excellent electrical and mechanical properties.



Foam filled Hotsticks

# HOTSTICKS & TOOLS

Hot sticks and switch sticks from Honeywell Salisbury are engineered to keep utility workers safe when they are on the line. Salisbury hot sticks feature closed cell foam filled fiberglass handles and are engineered to meet or exceed ASTM F711 safety standards and utilize premium materials for both safety and tool durability. Honeywell Salisbury is recognized globally for its manufacturing of personal protective equipment and live line tools to protect electrical workers from the hazards of their job.

### FAQ

**Q: Are rescue sticks required to be periodically electrically tested?**

**A:** Yes, see OS HA 1910.269(j) for specific testing requirements.

Hotstick production is 100% electrically proof tested. Hotstick blanks must pass a test of 100 kV/12 in (305 mm) for 5 minutes without detectable heating prior to being accepted. Hot Stick blanks conform with ASTM F711 requirements.

### LIVE LINE WORK MINIMUM APPROACH DISTANCE

Nominal Voltage (kV) Phase-to-Phase	Distance: ft in (m)	
	Phase-to-Ground Exposure	Phase-to-Phase Exposure
0.05 to 0.3	avoid contact	avoid contact
0.301 to 0.75	1 ft 1 in (0.33 m)	1 ft 1 in (0.33 m)
0.751 to 5	2 ft 0.8125 in (0.63 m)	2 ft 0.8125 in (0.63 m)
5.1 to 15	2 ft 1 in (0.65 m)	2 ft 2 in (0.68 m)
15.1 to 36	2 ft 6 in (0.77 m)	2 ft 11 in (0.89 m)
36.1 to 46	2 ft 9 in (0.84 m)	3 ft 2 in (0.98 m)
46.1 to 72.5	3 ft 3 in (1 m)	3 ft 11 in (1.2 m)
Voltage Range Phase-to-Phase (kV)	Distance: ft in (m)	
	Phase-to-Ground Exposure	Phase-to-Phase Exposure
72.6 to 121	3 ft 8 in (1.13 m)	4 ft 7 in (1.42 m)
121.1 to 145	4 ft 3 in (1.3 m)	5 ft 4 in (1.64 m)
145.1 to 169	4 ft 9 in (1.46 m)	6 ft 4 in (1.94 m)
169.1 to 242	6 ft 7 in (2.01 m)	10 ft 1 in (3.08 m)
242.1 to 362	11 ft 2 in (3.41 m)	18 ft 1 in (5.52 m)
362.1 to 420	13 ft 11 in (4.25 m)	22 ft 4 in (6.81 m)
420.1 to 550	16 ft 7 in (5.07 m)	27 ft 0.375 in (8.24 m)
550.1 to 800	22 ft 6 in (6.88 m)	37 ft 4 in (11.38 m)

These distances take into consideration the highest switch surge an employee will be exposed to on any system with air as the insulating medium and the maximum voltage shown.

The clear live-line total distances shall equal or exceed the values for the indicated voltage ranges.

## FIBERGLASS REINFORCED PLASTIC CLAMPSTICKS

### SPECIFICATIONS AND INFORMATION

- Tough thermoplastic head ferrule
- EZ Grip plastic hand grip
- Wide opening 0.9375 in (23.8 mm)
- Stainless steel hook
- Heavy duty rubber end cap

### EXTERNAL ROD CLAMPSTICKS

External Rod Clampsticks are constructed of closed cell foam-filled tubular fiberglass in accordance with ASTM standard F711. The hook's operating rod, made of solid 0.375 in (9.5 mm) dia. fiberglass, is mounted on the exterior of the tool so that it can be easily wiped down prior to use.

These Clampsticks meet ASTM F1825 Standards.

EXTERNAL ROD CLAMPSTICK			
Item #	Length		Weight each lb (kg)
	ft	m	
4007-ES	4 ft 8 in	1.32 m	4.2 lb (1.9 kg)
4008-ES	5 ft 8 in	1.62 m	4.6 lb (2.1 kg)
4009-ES	6 ft 8 in	1.93 m	5.2 lb (2.4 kg)
4010-ES	8 ft 8 in	2.54 m	6.2 lb (2.8 kg)
4011-ES	10 ft 8 in	3.15 m	7 lb (3.2 kg)
4012-ES	12 ft 8 in	3.76 m	7.7 lb (3.5 kg)
4013-ES	14 ft 8 in	4.37 m	9.4 lb (4.3 kg)

Add a "9864-ES" suffix for a Switch Stick Head or a "9840-ES" suffix for a Splined Universal Head. Clamp sticks may be ordered with these fittings attached to the end by adding the appropriate suffix to the catalog number.

EXTERNAL ROD CLAMPSTICK - PLAIN CAP			
Item #	Length		Weight each lb (kg)
	ft	m	
8106C-ES	6 ft 6 in	1.98 m	5 lb (2.27 kg)



External Rod Clampstick

Side Opening Hook

9840-ES Splined Universal Head

## UNIVERSAL SWITCH STICKS

One, two and three section hotsticks have a standard splined universal head. 1.25 in dia. switch sticks are supplied with a #9971-ES Prong. A Heavy Duty Disconnect Prong #9969-ES is supplied on all others.

ONE SECTION			
Item #	Dimensions: Dia. × Length		Weight each lb (kg)
	in × ft	mm × m	
4213-ES	1.25 in × 4 ft	31.7 mm × 1.2 m	2.6 lb (1.2 kg)
4214-ES	1.25 in × 6 ft	31.7 mm × 1.8 m	3.4 lb (1.5 kg)
4215-ES	1.25 in × 8 ft	31.7 mm × 2.4 m	4.1 lb (1.9 kg)
4216-ES	1.25 in × 10 ft	31.7 mm × 3 m	4.9 lb (2.2 kg)
4219-ES	1.5 in × 8 ft	38.1 mm × 2.4 m	5.4 lb (2.5 kg)
4225-ES	1.5 in × 20 ft	38.1 mm × 6 m	11.7 lb (5.3 kg)

TWO SECTION							
Item #	OAL Length		Top		Bottom		Weight lb (kg)
	ft	m	in × ft	mm × m	in × ft	mm × m	
4037-ES	10 ft	3 m	1.25 in × 5 ft	31.7 mm × 1.5 m	1.25 in × 5 ft	31.7 mm × 1.5 m	5.2 lb (2.2 kg)
4040-ES	16 ft	4.9 m	1.25 in × 8 ft	31.7 mm × 2.4 m	1.5 in × 8 ft	38.1 mm × 2.4 m	8.6 lb (3.9 kg)

THREE SECTION							
Item #	OAL Length		Top		Bottom		Weight lb (kg)
	ft	m	in × ft	mm × m	in × ft	mm × m	
4044-ES	15 ft	4.6 m	1.25 in × 5 ft	31.7 mm × 1.5 m	1.5 in × 5 ft	38.1 mm × 1.5 m	9.1 lb (4.1 kg)

HEAD ONLY				
Item #	Top		Bottom	Weight lb (kg)
	in	mm		
9840-ES	1.25 in	31.7 mm	Universal Head	0.2 lb (0.1 kg)
9841-ES	1.5 in	38.1 mm	Universal Head	0.3 lb (0.1 kg)



9969-ES Prong

9971-ES Prong

FRP Splices with Button

Universal Switch Stick

## FIBERGLASS HOT SWITCH STICKS

### SWITCH STICKS

Switch Sticks use closed cell foam filled tubular fiberglass made in accordance with ASTM Standard F711. Both the standard head and the heavy duty prong disconnect are made of durable high strength aluminum bronze alloy.

ONE SECTION				
Item #		Dimensions: Dia. × Length		Weight each
HD	ST	in × ft	mm × m	lb (kg)
9950-ES	9933-ES	1.25 in × 4 ft	31.7 mm × 1.2 m	2.1 lb (1 kg)
9951-ES	9934-ES	1.25 in × 6 ft	31.7 mm × 1.8 m	2.9 lb (1.3 kg)
9952-ES	9935-ES	1.25 in × 8 ft	31.7 mm × 2.4 m	3.6 lb (1.6 kg)
9953-ES	9936-ES	1.25 in × 10 ft	31.7 mm × 3 m	4.4 lb (2 kg)
9954-ES	-	1.25 in × 12 ft	31.7 mm × 3.6 m	5.1 lb (2.3 kg)
9955-ES	9938-ES	1.25 in × 14 ft	31.7 mm × 4.3 m	5.9 lb (2.7 kg)
9956-ES	-	1.5 in × 8 ft	38.1 mm × 2.4 m	5 lb (2.3 kg)
9957-ES	9940-ES	1.5 in × 10 ft	38.1 mm × 3 m	6 lb (2.7 kg)
9958-ES	-	1.5 in × 12 ft	38.1 mm × 3.6 m	7 lb (3.2 kg)
9959-ES	9942-ES	1.5 in × 14 ft	38.1 mm × 4.3 m	8.1 lb (3.7 kg)
9960-ES	9943-ES	1.5 in × 16 ft	38.1 mm × 4.9 m	9.1 lb (4.1 kg)
-	9944-ES	1.5 in × 18 ft	38.1 mm × 5.5 m	10.2 lb (4.6 kg)
9962-ES	-	1.5 in × 20 ft	38.1 mm × 6 m	11.2 lb (5.1 kg)



Standard Prong (ST)



Heavy Duty Prong (HD)



Fiberglass Hot Switch Stick



## UNIVERSAL SWITCH STICKS & ACCESSORIES

### DOUBLE ENDED & TIE HEADS

#### SPLICE GUARDS

Splice Guards reduce the damage to the end of spliced sticks when working with only the top sections.

These foam filled FRP Hot Sticks are manufactured using a pultrusion process that results in a product with extremely high electrical and mechanical qualities.

DOUBLE ENDED UNIVERSAL				
Item #	Description	Dimensions: Dia. × Length		Weight each
		in × ft	mm × m	lb (kg)
4230-ES	Stick-tie w/univ both ends 72	1.25 in × 6 ft	31.7 mm × 1.8 m	3.3 lb (1.5 kg)



Double Ended Universal Switch Stick

THREE SECTION							
Item #	OAL Length		Top		Bottom		Weight
	ft	m	in × ft	mm × m	in × ft	mm × m	
4034-ES	20 ft	2 m	1.25 in × 8 ft	31.7 mm × 2.4 m	1.5 in × 6 ft	38.1 mm × 1.8 m	11.1 lb (5 kg)

## FIBERGLASS HOT SWITCH STICKS

### DOUBLE ENDED

#### FIBERGLASS HANDLES

Fiberglass Handles are manufactured in accordance with the following specifications: ASTM F711, OSHA 1910.269(j), and OSHA 1926.951(d). All handles are made from pultruded, smooth, foam-filled fiberglass. Safety yellow is the primary fiberglass color. It is recommended that handles be wiped clean with a silicote cloth before and after every use.

The most commonly used combinations are shown below. Other lengths are available. Bags are not included but are available.

CAP & THREADED FERRULE			
Item #	Description	Diameter x Overall Length	Weight
			lb (kg)
10078CH-ES	1 in x 78 in handle w/cap & ferrule	1 in x 6 ft 6 in (2.5 cm x 1.98 m)	2 lb (0.91 kg)
10096CH-ES	Hotstick fg 1 in x 8 fg	1 in x 8 ft (2.5 cm x 2.44 m)	2 lb (0.91 kg)
12578CH-ES	1.25 in x 6 ft 6 in fg handle w/ cap & hex	1.25 in x 6 ft 6 in (3.2 cm x 1.98 m)	2 lb (0.91 kg)
12596CH-ES	SL Hotstick 1.25 in x 8 ft cap & hex ferrule	1.25 in x 8 ft (3.2 cm x 2.44 m)	3 lb (1.36 kg)
15096CH-ES	1.5 in x 8 ft Hotstick w/cap & qc hex	1.5 in x 8 ft (3.8 cm x 2.44 m)	6 lb (2.72 kg)
TWO THREADED FERRULES			
10078HH-ES	1 in x 78 in handle w/ferrule	1 in x 6 ft 6 in (2.5 cm x 1.98 m)	2 lb (0.91 kg)
10096HH-ES	1 in x 8 ft fg handle w/2 hex ferrule	1 in x 8 ft (2.5 cm x 2.44 m)	2 lb (0.91 kg)
12578HH-ES	SL Hotstick 1.25 in x 6 ft 6 in w/2 threaded ferrule	1.25 in x 6 ft 6 in (3.2 cm x 1.98 m)	3 lb (1.36 kg)
12596HH-ES	1.25 in x 8 ft fg handle w/2 hex ferrules	1.25 in x 8 ft (3.2 cm x 2.44 m)	4 lb (1.81 kg)
15078HH-ES	1.5 in x 78 in Hotstick, hex ferrule ends	1.5 in x 6 ft 6 in (3.8 cm x 1.98 m)	3 lb (1.36 kg)
15096HH-ES	1.5 in x 8 ft fg handle w/2 hex ferrules	1.5 in x 8 ft (3.8 cm x 2.44 m)	6 lb (2.72 kg)
150120HH-ES	1.5 in x 10 ft Hotstick w/cap qc, hex ends	1.5 in x 10 ft (3.8 cm x 3.05 m)	6 lb (2.72 kg)
TWO INSULATED HEX FERRULES			
12578HHM-ES	1.25 in x 6 ft 6 in fg handle w/ hex ferrule threaded	1.25 in x 6 ft 6 in (3.2 cm x 1.98 m)	4 lb (1.81 kg)
12596HHM-ES	Handle 1.25 in w/ins hex	1.25 in x 8 ft (3.2 cm x 2.44 m)	4 lb (1.81 kg)
CAP & UNIVERSAL FERRULE			
10078CU-ES	1 in x 78 in handle w/ cap & ferrule	1 in x 6 ft 6 in (2.5 cm x 1.98 m)	2 lb (0.91 kg)
12578CU-ES	Handle fiberglass 1.25 in x 6 ft 6 in	1.25 in x 6 ft 6 in (3.2 cm x 1.98 m)	2 lb (0.91 kg)



Quick Change Head

12578HH-ES

15078CH-ES

## TOGGLE HANDLE FIBERGLASS CLAMPSTICKS

### MAKE THE JOB EASIER – SPECIALIZED TOGGLE HANDLE INCREASES LEVERAGE.

The toggle handle fiberglass hot switch sticks and clampsticks include a bendable handle that provides increased leverage when needed.

#### FIBERGLASS HOT SWITCH STICKS

Fiberglass Hot Switch sticks are manufactured in accordance with the following specifications: ASTM F711, OSHA 1910.269(j), and OSHA 1926.951(d). All handles are made from pultruded, smooth, foam filled fiberglass. Safety yellow is the primary fiberglass color. It is recommended that handles be wiped clean with a silicote cloth before and after every use.

#### FIBERGLASS CLAMPSTICKS

All Fiberglass Clampsticks are fixed length external rod fiberglass clampsticks which maintain maximum dielectric strength. A full open side hook provides an unobstructed view of the hook. The molded, insulated head provides a larger opening. The precision cast slide gives complete control and an extra firm grip. The hook release mechanism is easy to operate and the extended length spear provides an easy method of locating the eye of hot taps that are other-wise hard to locate.

Bag not included.

TOGGLE HANDLE & THREADED FERRULE			
Item #	Dimensions: Dia. x Length		Weight
	in x ft	cm x m	lb (kg)
12596HE-ES	-	-	-
12578HE-ES	1.25 in x 6 ft 6 in	3.2 cm x 1.98 m	4 lb (1.81 kg)
12548HE-ES	1.25 in x 4 ft	3.2 cm x 1.22 m	4 lb (1.81 kg)
TOGGLE HANDLE & UNIVERSAL FERRULE			
12578UE-ES	1.25 in x 6 ft 6 in	3.2 cm x 1.98 m	4 lb (1.81 kg)
12596UE-ES	1.25 in x 8 ft	3.2 cm x 2.44 m	4 lb (1.81 kg)
TOGGLE HANDLE & INSULATED HEX FERRULE			
12578HEM-ES	1.25 in x 6 ft 6 in	3.2 cm x 1.98 m	4 lb (1.81 kg)
OAL TOGGLE HANDLE FIBERGLASS CLAMPSTICK			
8104E-ES	4 ft 6 in	1.37 m	4.5 lb (2.04 kg)
8106E-ES	6 ft 6 in	1.98 m	5 lb (2.27 kg)

All fiberglass used is tested at 50 kV / 6 in (100 kV / ft) and meets the dielectric leakage requirements of ASTM F711.

**TOGGLE MAXIMUM TORQUE RATING: 60 FOOT POUNDS.**



Closeup

12578HE-ES



## SPECIALTY HOT SWITCH STICKS

### MECHANICAL HAND STICK

The Mechanical Hand Stick serves both as a hand and as pliers so that any serve-up or type of tie can be made or removed from the line. Very little effort is required to serve a wire taut and as perfectly as when hand and pliers are used. It is possible to roll the wire into place around the conductor, making a tight connection easily, instead of jerking and pulling.

MECHANICAL HAND HEAD ONLY			
Item #	Description	Handle Length	Weight
			lb (kg)
1CQ-ES	Mechanical Hand w/ Quick Change	-	1 lb (0.45 kg)
1CU-ES	Mechanical Hand w/ Universal	-	1 lb (0.45 kg)



## SPECIALTY HOT SWITCH STICKS

### WIRE CLAMP STICK

The Wire Clamp Stick has two fiberglass handles: the operating handle is 1 in (2.5 cm) in diameter and the stationary handle is 1.25 in (3.2 cm) in diameter. The wire clamp stick is used to hold tie wires in place, hold jumper wires while taps are being made or removed, and to hold wires when cutting and removing.

### ALLIGATOR STICK

Use the Alligator Stick to install and remove single sheave or double blocks in the top of gin poles and to install circuit breakers, line hooks and strain breakers on live lines. With the alligator stick, you can remove arm slings on cross arms and hook blocks in arm slings and come-alongs when changing dead ends.

WIRE CLAMP STICK			
Item #	Description	Handle Length	Weight
			lb (kg)
2FGQ-ES	Quick Change	6 ft 6 in (1.98 m)	6 lb (2.72 kg)

WIRE CLAMP HEAD ONLY			
Item #	Description	Handle Length	Weight
			lb (kg)
2CQ-ES	Wire with Quick Change	-	3 lb (1.36 kg)



### ALLIGATOR STICK, FIBERGLASS HANDLE DIAMETER: 1.25 IN (3.2 CM)

Item #	Description	Handle Length	Weight
			lb (kg)
4FGQ-ES	Quick Change	6 ft 6 in (1.98 m)	4 lb (1.81 kg)

ALLIGATOR HEAD ONLY			
Item #	Description	Handle Length	Weight
			lb (kg)
4DU-ES	Alligator with Universal	-	1 lb (0.45 kg)
4DQ-ES	Alligator with Quick Change	-	1 lb (0.45 kg)



## SPECIALTY HOT SWITCH STICKS

### PIGTAIL STICK

The Pigtail Stick is designed to lift and guide live lines and maintains clearances while working on poles. The pigtail stick is used to change pin type insulators and ridge pin insulators when the conductor is light enough for one person to lift. Units come standard with 0.875 in (2.2 cm) hook; also available with 1.5 in (3.8 cm) and 2 in (5.1 cm) hooks. Other lengths available. Bag not included. Fiberglass handle diameter: 1.5 in (3.8 cm).

### STRANDED WIRE HOLDING STICK

The Stranded Wire Holding Stick has two 1 in (2.5 cm) diameter fiberglass handles, holds conductors or wires during operations. The 121 Series has 0.75 in (1.9 cm) wide jaws that open to 0.5625 in (1.4 cm), and the 122 Series, has 2 in (5.1 cm) wide jaws that open to 1.5 in (3.8 cm). Other lengths available. Bag not included.

### CABLE HANDLER

The Cable Handler has a 1.25 in (3.2 cm) fiberglass handle. Used to handle, lift, or move energized cables. Other lengths available.

PIGTAIL HEAD ONLY			
Item #	Handle Length		Weight
	in	cm	lb (kg)
5C2Q-ES	0.875 in	2.2 cm	1 lb (0.45 kg)
5C3U-ES	1.5 in	3.8 cm	1 lb (0.45 kg)
5C2U-ES	0.875 in	2.2 cm	1 lb (0.45 kg)
5C4U-ES	2 in	5.1 cm	1 lb (0.45 kg)
5C3Q-ES	1.5 in	3.8 cm	1 lb (0.45 kg)
5C4Q-ES	2 in	5.1 cm	1 lb (0.45 kg)

CABLE HANDLER		
Item #	Handle Length	Weight
		lb (kg)
5020HQ-ES	-	-



## SECTIONALIZER KIT & INSULATING LINK STICKS

### SECTIONALIZER KIT

The Sectionalizer Kit temporarily disconnects and isolates a section of line without interrupting service to the balance of the circuit. The entire operation of installation and removal of the sectionalizers can be performed with live line tools. Particularly useful when circuits are interrupted as a result of conductor, insulation or pole failures. Service can be restored by cutting in sectionalizers to isolate the section of line that is in trouble.

Consists of 1.75 in foam-filled fiberglass connected to a manually operated take-up device. The strain of the line is taken by means of the take-up device using the hook (Cat. No. 1370H), which fastens on the end of the socket wrench (Cat. No. 596FG or equal). The conductor is then cut and cleared.

### INSULATING LINK STICKS

The Insulating Link Sticks are designed to isolate rope, hoists, and blocks being used between energized conductors and a pulling device. They also provide dielectric properties if strap hoist becomes contaminated through field use. Cat. Nos. 2512, 2518, and 2524 are made with solid fiberglass. All insulating link sticks are proof tested and marked with WLL prior to shipment. Other lengths and configurations available. All bags hold 3 link sticks. Bags not included.

Fiberglass used meets the requirements of ASTM F711.

SECTIONALIZER KIT		
Item #	Description	Weight
		lb (kg)
1370SL	Set includes: 3 of 1370A, 1 of 1370H, 1 of 1370FB	100 lb (45.3 kg)
PARTS		
1370H	Hook with 0.5 in Drive	1 lb (0.45 kg)
1370HR	Hold Down Hook with Ring	1 lb (0.45 kg)
1370V	Wire Holder, 0.5625 in (1.43 cm) max. size wire	2 lb (0.91 kg)
1370FB	Box w/ Inserts 44 in × 12 in × 16 in (112 cm × 31 cm × 41 cm)	60 lb (27.22 kg)

INSULATING LINK STICKS							
Item #	Overall Length	Length Between	Fiberglass	WLL	Weight	Cat. No.	Weight
	in (cm)	Ferrules in (cm)	Diameter in (cm)	lb (kg)	lb (kg)		lb (kg)
5012-ES	22 in (55.9 cm)	12 in (30.5 cm)	1.25 in (3.2 cm)	1,500 lb (682 kg)	2 lb (0.91 kg)	B522 Bag	1 lb (0.45 kg)
5112-ES	24 in (61 cm)	12 in (30.5 cm)	1.5 in (3.8 cm)	2,500 lb (1,134 kg)	2 lb (0.91 kg)	B522 Bag	1 lb (0.45 kg)



## FERRULES & ACCESSORIES

### FERRULES

Universal and 0.625 in - 11 threaded hex ferrules are available for 1 in (2.5 cm), 1.25 in (3.2 cm), and 1.5 in (3.8 cm) diameter fiberglass handles. Ferrules include a disc and rivet.

HEXAGONAL FERRULES			
Item #	Description	Size	Weight
			lb (kg)
4EFG-ES	0.625 in - 11 - Zinc	1.25 in (3.2 cm)	5 lb (156 kg)
4EFGM-ES	Insulated Hex Ferrule w/ Brass Threaded Insert 0.625 in - 11	1.25 in (3.2 cm)	5 lb (156 kg)
44DFG-ES	-	-	-



## HOTSTICK ACCESSORIES

### KITS

Kits include all material required to replace insulated stick ferrules. Please specify size. Each kit includes: one ferrule, one rivet, one disc for handle, sandpaper, a two-part adhesive and instructions.

### SALCOR® TOOL HOLDERS

SALCOR® Tool Holders secure tools to trailers, compartments and tool rooms. 12 per package.

### HOTSTICK BAGS

Hotstick Bags are constructed of heavy vinyl with double stitched seams. Flaps snap closed. 6 in (152mm) wide and designed to hold sticks up to 4 in (102mm) shorter than bag length shown on chart.

HEXAGONAL FERRULE KITS			
Item #	Description	Size	Weight
			lb (kg)
4EK001-ES	0.625 in - 11 - Zinc	1.25 in (3.2 cm)	4 lb (124 kg)
2000SC-ES	Silicote Cloth	-	4 lb (124 kg)
C125-ES	1.25 in (3.2 cm) Cap	-	-

SALCOR® TOOL HOLDERS			
Item #	Description		Weight
	in	mm	lb (kg)
1192-ES	1.25 in	32 mm	3.5 lb (1.6 kg)

HOTSTICK BAGS			
Item #	Description/Length		Weight
	ft	m	lb (kg)
4297-ES	5 ft	1.5 m	.7 lb (0.3 kg)
4298-ES	6 ft	1.8 m	.8 lb (0.3 kg)
4299-ES	6 ft 4 in	1.9 m	.9 lb (0.4 kg)
4301-ES	8 ft 4 in	2.5 m	1.1 lb (0.5 kg)
4302-ES	9 ft	2.7 m	1.2 lb (0.5 kg)
4303-ES	10 ft 4 in	3 m	1.4 lb (0.6 kg)

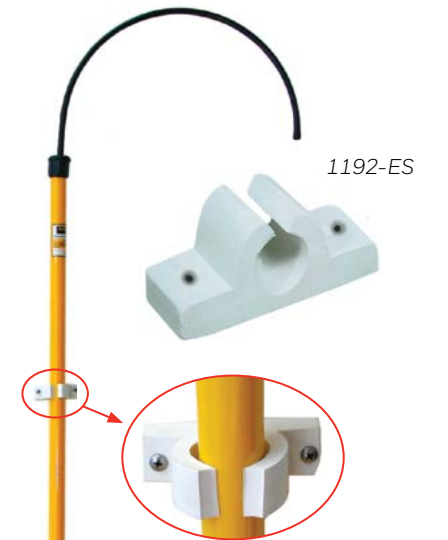

## STORAGE FOR HOTSTICKS & TOOLS

### TUBULAR PVC STORAGE CONTAINERS

Tubular PVC Storage Containers provide weather tight storage. Kit includes two mounting brackets and four steel bolts with each 6 in (152 mm) I.D. or 4.1 in (104 mm) tube. Sized for tools 12 in (305 mm) shorter than tube. Four mounting bolts 0.375 in x 1.5 in (9.5 mm x 38 mm) are supplied with each container. Kit may be ordered without tubing or with mounting brackets only.

#### 4 IN I.D. TUBULAR PVC STORAGE KIT

Item #	Description/Length		Weight lb (kg)
	ft	m	
4155-ES	7 ft	2.13 m	17 lb (7.7 kg)
4156-ES	9 ft	2.74 m	20 lb (9 kg)

#### 6 IN I.D. TUBULAR PVC STORAGE KIT

Item #	Description/Length		Weight lb (kg)
	ft	m	
4167-ES	6 ft	1.82 m	20 lb (9 kg)
4168-ES	7 ft	2.13 m	22 lb (10 kg)
4169-ES	9 ft	2.74 m	26 lb (11.7 kg)



## RESCUE HOOK & STATIC DISCHARGE STICK

### INSULATED RESCUE HOOK

Salisbury's insulated rescue hook is an invaluable tool for any workplace. It is used to release a victim from contact. Confined spaces, in vaults, or just near electrical cabinets and switch gear are some of the places where this tool is a must. Insulated rescue hooks feature a foam-filled, fiberglass reinforced handle for superior electrical insulation and a coated, heat treated body hook with an 18 in opening and are made in accordance with ASTM Standard F711. The stick is available in the standard lengths of 6 and 8 ft. Other lengths are available as a special order. Contact us with your requirements.

### STATIC DISCHARGE STICK

The Static Discharge Stick is designed to safely remove the static charge after de-energizing. This tool is pre-assembled and includes a brass alloy "U" hook, closed cell foam-filled tubular fiberglass switch stick made in accordance with ASTM Standard F711. Static discharge sticks have 6 ft of copper grounding cable attached to a Salisbury 1814 flat jaw, grade 3, bronze serrated clamp with strain relief.

#### INSULATED RESCUE HOOK

Item #	Description	Dimensions: Length		Weight lb (kg)
		ft	m	
24400-ES	Rescue Hook	3 ft	0.9 m	3.4 lb (1.5 kg)
24401-ES	Rescue Hook	6 ft	1.8 m	4.5 lb (2 kg)
24403-ES	Rescue Hook	8 ft	2.4 m	5.5 lb (2.5 kg)

#### STATIC DISCHARGE STICK

Item #	Description	Dimensions: Length		Weight lb (kg)
		ft	m	
20817-ES	Static Discharge Stick	3 ft 8 in	1.08 m	8 lb (3.6 kg)
22629-ES	Static Discharge Stick w/ Universal Attachment	1 ft	0.3 m	0.38 lb (0.17 kg)

#### ⚠ WARNING

Discharge sticks are not grounding tools as described by OSHA 1910.269 and carry no fault duty rating.



24401-ES  
Rescue Hook  
(Shown with Tool Holder)

20817-ES

22629-ES Static Discharge  
Stick w/ Universal Attachment

## STATIC DISCHARGE STICKS

### DISCHARGE HOOK

A Discharge Hook is used to drain capacitive voltage. The probe is first used to make contact, then the hook can be used to make direct contact bypassing the fuse. The fuse gives added protection in case initial contact is accidentally made on energized equipment. Fuse is rated at 8 kV maximum, 6 amperes continuous.

A Discharge Hook is a special discharging device used to de-energize capacitors and other voltage retaining components before maintenance work is performed. Mounting clip (Cat. No. 1925MC) is included. Standard handle length is 2 ft (0.61 m). Other cable and handle lengths are available.

### RESISTIVE DISCHARGE HOOKS/PROBES

Resistive Discharge Hooks/Probes with resistors help eliminate initial surge current. Second hook bypasses resistors for residual discharge. Resistive discharge hooks and probes use #6 flexible copper, clear-jacketed cable, a hand guard, hook or probe, and a 1 in (2.5 cm) diameter fiberglass insulating handle. The handle complies with ASTM F-711. All come with a clear PVC cover to protect resistors from damage from bumps and knocks. Not all resistors fit all hooks. Please note resistor's outside diameter and length. Mounting clip (Cat. No. 1925MC) is included. Other lengths and configurations are available.

#### FUSED DISCHARGE HOOK

Item #	Weight
	lb (kg)
1930535415Q-ES	10 lb (4.53 kg)

#### DISCHARGE HOOK

Item #	Dimensions	Weight
	ft (m)	lb (kg)
1925-ES	5 ft (1.52 m)	2 lb (0.91 kg)
19258-ES	8 ft (2.44 m)	3 lb (1.36 kg)
192510-ES	10 ft (3.05 m)	4.5 lb (2.04 kg)
192520-ES	20 ft (6.10 m)	5 lb (2.27 kg)

#### RESISTIVE DISCHARGE HOOK/PROBES

Item #	Handle Length	Ground Lead Length	Weight
	ft (m)	ft (m)	lb (kg)
19250007-ES	5 ft (1.52 m)	7 ft (2.13 m)	4 lb (1.81 kg)
19250005-ES	1 ft 11 in (0.58 m)	5 ft (1.52 m)	2 lb (0.91 kg)
19250006-ES	-	-	-
192500655-ES	7 ft (2.13 m)	10 ft (3.05 m)	4.5 lb (2.04 kg)

#### ACCESSORIES

Item #	Weight
	lb (kg)
1925MC-ES	3 oz (0.084 kg)

FOR DISCHARGE ONLY. DO NOT USE AS LIVE LINE TOOL OR GROUNDING DEVICE.



## TOOLS

### TOOL HEADS

Tool Heads are used in live line applications. This equipment should be mounted on suitable handles to ensure proper distance from live conductors. Below are the choices of end fittings available. All tools have one of these three fittings.



#### Quick Change End Fitting

Has a 0.625 in - 11 threaded stud that threads into the top of a hexagonal ferrule. A hexagonal collar slides down and over the hexagonal ferrule making a strong, positive connection. A plastic safety clip is used to lock the quick change end fitting to an insulating handle.

#### Universal End Fitting

Gives the user the option to position and secure an universal tool head at several angles. It also allows meters to be attached to universal handles. Universal fittings can be installed on universal sticks by using the 2500 shotgun adaptor.

#### Grip All or Eye Screw End Fitting

For use with the clamp stick. The hook from the clamp stick is hooked through the eye hole of the eye screw, then drawn into the clamp stick and secured.



#### Safety Clip for Quick Change

Locks a quick change tool head to handle. 320E • 0.1 oz (3 g)



#### Convertible Adapter

3401Q • Changes QC to U • 1 lb (0.45 kg)



#### Convertible Adapter

2500 • Shotgun Adaptor • 0.4 lb (0.2 kg)



#### Bayonet Ferrule

Installs/removes ground heads with bayonet studs. 98B\* • 1 lb (0.45 kg)



#### Toggle & Spring

The 0.5 in (1.3 cm) square drive converts handles into a socket stick. 5900\* • 2 lb (0.91 kg)



#### Handle Splice Joint & Spring

Splices two handles together creating a flexible handle. 3302\* • 2 lb (0.91 kg)

\* Add suffix "U" for Universal, "Q" for Quick Change

**TOOLS**



**Pin Holder for Clevis-Type Insulators**  
2900\* • 1 lb (0.45 kg)



**Cotter Key Installer**  
3500\* • 1 lb (0.45 kg)



**Switch Disconnect w/ Hammer Head**  
1900U • 0.19 lb (0.08 kg)



**Quick Change Handle Splice Joint**  
3301 • 2 lb (0.91 kg)



**Clamp Stick Head**  
9834 • Clamp Stick Head • 1.4 lb (0.6 kg)



**Alligator**  
4D\* • Alligator • 1 lb (0.45 kg)



**Adjustable Insulator Fork**  
8300Q-ES • 2 lb (0.91 kg)



**Mechanical Hand**  
1C\* • 1 lb (0.45 kg)



**Inspection Mirror**  
9900Q-ES • 5 in (12.7 cm) dia. • 8 oz (224 g)



**Cotter Key Remover**  
11Q-ES • Remover • 12 oz (0.38 kg)  
1101Q-ES • Spring Loaded Remover • 12 oz (0.38 kg)



**Extension Offset Switch Hook**  
Safely removes fuses from outdoor disconnects.  
190001\* • Steel • 1 lb (0.45 kg)  
190002U-ES • Aluminum/Bronze • 1 lb (0.45 kg)



**Line Hose Applicator**  
2 in x 18 in (5.1 cm x 45.7 cm) jaws  
1680\* • 4 lb (1.81 kg)



**Hanging Hook**  
Attaches to all fiberglass handles.  
190HC • 3 oz (84 kg)



**Double Prong Tie Head**  
4101 • 0.5 lb (0.22 kg)



**Convertible Adapter**  
0.625 in - 11 Internal Thread  
3403 • Changes QC to U • 3 oz (93 g)

\* Add suffix "U" for Universal, "Q" for Quick Change

**TOOLS**



**Switch Hook**  
190Q-ES • 8 oz (0.25 kg)



**Wire Grip**  
Grips conductor, has hole for block or line hook. WWL for grips 1,000 lb (454 kg) at a 4:1 ratio.  
3600Q-ES • Opening min. 0.3125 in max. 0.875 in 2 lb • (7.9 mm, 2.2 cm) • (0.91 kg)  
3601Q-ES • Opening min. 0.5 in max. 1.5 in 3 lb. • (1.3 cm, 3.8 cm) • (1.36 kg)



**Pig Tail**  
5C2\* • 0.875 in (2.2 cm) opening • 1 lb (0.45 kg)  
5C3\* • 1.5 in (3.8 cm) opening • 2 lb (0.91 kg)  
5C4 • 2 in (5.1 cm) opening • 2 lb (0.91 kg)



**Tree / Wire Hook**  
4236 • 0.36 lb (0.2 kg)



**Pig Tail Disconnect**  
9878 • 0.4 lb (0.2 kg)



7991\* • Pruning Saw w/ 14 in (35.6 cm) 1 lb (0.45 kg) • 7991WS Saw Sheath 0.5 lb. (0.22 kg)



152Q-ES • "V" Brush • 1.5 lb (0.68 kg)  
152B • Replacement Brush • 3 oz (0.09 kg)



1520010GAH  
Brush w/ Handle & Cover • 1 lb (0.45 kg)



4106 • Curved Blade Skinning Knife • 0.4 lb (0.2 kg)



**Test Point Cap Seal Cleaner**  
1520006\* • 1 lb (0.45 kg)

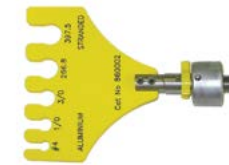

**Wire Gauges**  
864000U-ES • ACSR/Aluminum Fits: #4 to 0.556 • 1 lb (0.45 kg)



Mounted on 12 in (30.6 cm) fiberglass pole  
4105 • Tree Pruner - Universal • 25 ft (7.62 m) of line • 4 lb (1.81 kg)  
7992FGQ • Tree Pruner - Quick Change • 12 ft (3.06m) of line • 4 lb (1.81 kg)

\* Add suffix "U" for Universal, "Q" for Quick Change

## ARMOR ROD TOOLS, JUMPER HEADS & PENTA SOCKETS

### JUMPER HEADS

The Jumper Heads have a maximum opening of 1.5625 in (4 cm) and are designed with built-in universal joints in order to accommodate installation lines at an angle. The jumper heads have a quick action tightening screw for fast closing. Threaded adapters are used to accept 0.625 in - 11 threaded non-shrouded ferrules. A hose clamp is included for connection strain relief.

### PENTA SOCKET

Use the Penta Socket to tighten or loosen special 0.75 in (19 mm) penta head sockets. Comes with a "T" handle. Can be used with any 0.5 in (13 mm) drive wrench.

ARMOR ROD TOOLS		
Item #	Description	Weight lb (kg)
1241Q-ES	Formed Wire Tool w/Quick Change Head	2 lb (0.91 kg)
1241U-ES	Formed Wire Tool w/Universal Head	2 lb (0.91 kg)

PENTA SOCKET		
Item #	Description	Weight lb (kg)
590001S-ES	Penta head Socket - 0.75 in (11 mm)	1 lb (0.45 kg)
590001-ES	"T" Wrench with 0.75 in (11 mm) Penta head Socket	1 lb (0.45 kg)
5900017/16T-ES	"T" Wrench with 0.75 in (11 mm) Penta head Socket and 0.4375 in depth	1 lb (0.45 kg)

\* Add suffix "Q" for quick change, "U" for universal, "HDQ" for heavy duty w/ quick change, "HDU" for heavy duty w/ universal.



## FUSE PULLER TOOLS

### FUSE PULLER

The standard Fuse Puller heads (Cat. No. 92Q) have plastic jaws that fit fuses from 0.75 in (1.9 cm) to 2 in (5.1 cm) diameter. Heads are pivotally mounted to permit adjustment to any angle. To tighten the jaws, just rotate the handle. The insert jaws (Cat. No. 190NLF) for the 0.8125 in (2.1 cm) diameter liquid filled fuse are held on the fuse puller with springs. The attachment on the end of each fuse puller is Cat. No. 190Q, quick change switch hook. Other lengths available. Bag not included. Fiberglass handle diameter: 1.25 in (3.2 cm).

FUSE PULLER TOOL			
Item #	Description	Handle Length	Weight lb (kg)
196FGQ-ES	Quick Change	6 ft 6 in (1.98 m)	5 lb (2.27 kg)
196FGU-ES	Universal	6 ft 6 in (1.98 m)	5 lb (2.27 kg)
PARTS			
92Q-ES	Head Only, Quick Change	-	2 lb (0.91 kg)
92U-ES	Head Only, Universal	-	2 lb (0.91 kg)
190U-ES	Switch Hook, Universal	-	1 lb (0.45 kg)
190Q-ES	Switch Hook, Quick Change	-	1 lb (0.45 kg)
190NLF-ES	Insert Jaws for 0.8125 in (2.1 cm) diameter S & C Liquid Fuse	-	1 lb (0.45 kg)

FUSE PULLER HEADS			
Item #	Description	Maximum Diameter	Weight lb (kg)
9209Q-ES	Liquid Fuse, Quick Change	0.8125 in (2.1 cm)	3 lb (1.36 kg)
9209U-ES	Liquid Fuse, Universal, Head Only	0.8125 in (2.1 cm)	3 lb (1.36 kg)
92225001Q-ES	Quick Change	2.25 in (5.7 cm)	3 lb (1.36 kg)
92225001U-ES	Universal	2.25 in (5.7 cm)	3 lb (1.36 kg)



## CONNECTOR TOOL HEADS & PARALLEL GROOVE CLAMP

### PARALLEL GROOVE CLAMP TOOL

The Parallel Groove Clamp Tool accommodates cap-screw type parallel groove clamps (one, two and three bolt types). The parallel groove tool head clamps can be installed from almost any angle by use of the universal ball clamp. The handles are fiberglass, with the operating handle having a diameter of 1 in (2.5 cm) and the stationary handle 1.25 in (3.2 cm). Bag not included. Other lengths available.

### WISE TYPE CONNECTOR TOOL

The Vise Type Connector Tool installs and removes all sizes of single bolt vise type connectors on energized lines. With this tool it is possible to install connectors on a line as efficiently as when done by hand. The handles are fiberglass. The operating handle is 1 in (2.5 cm) in diameter and the stationary handle is 1.25 in (3.2 cm) in diameter. Bag not included. Other lengths available.

Order operating sticks separate.

PARALLEL GROOVE CLAMP TOOL HEAD		
Item #	Description	Weight
		lb (kg)
1800CQ-ES	Quick Change Head	3 lb (1.96 kg)
1800CU-ES	Universal Head	3 lb (1.96 kg)

PARALLEL GROOVE CLAMP TOOL SOCKET			
Item #	Description	Size	Weight
		in (cm)	lb (kg)
1800SSFB-ES	Socket w/Friction Ball	0.5625 in (1.4 cm)	1 lb (0.45 kg)
1800SS-ES	Deep Drive Socket	0.5625 in (1.4 cm)	1 lb (0.45 kg)
1800SM-ES	Drive Socket	0.75 in (1.9 cm)	1 lb (0.45 kg)
1800SL-ES	Drive Socket	0.9375 in (2.4 cm)	1 lb (0.45 kg)

CONNECTOR TOOL VISE TYPE HEAD		
Item #	Description	Weight
		lb (kg)
72CQ-ES	Quick Change Head Only	3 lb (1.96 kg)
72CU-ES	Universal Head Only	3 lb (1.96 kg)

CONNECTOR TOOL VISE TYPE		
Item #	Description	Weight
		oz (g)
72S3/4-ES	0.75 in (1.9 cm)	2 oz (45 g)
72S9/16-ES	0.5625 in (1.4 cm)	2 oz (45 g)



## HAND TOOLS & CUTTERS

### INSULATED RATCHET WRENCH FOR CLAMP TOP

The insulated ratchet wrench for clamp top has an 1.25 in (3.2 cm) diameter fiberglass handle with eye on end for use with a clamp top tool (Cat. Nos. 44CQ or 44CU).

### TOGGLE HANDLE

The toggle handle is used to convert any double threaded ferrule stick to a toggle handle for torquing requirements.

### LIVE LINE LEVER CUTTERS

Live line lever cutters are compound shear cutters made from a heat-treated alloy steel. The stationary handle is 1.5 in (3.8 cm) in diameter and the operating handle is 1 in (2.5 cm) in diameter. For cutting tie wires, jumper taps and conductors up to 2/0. Larger wires should be cut with ACSR lever cutters. Bags available. Not for use on ACSR.

HAND TOOLS			
Item #	Description	Size	Weight
		in (cm)	lb (kg)
44CFG-ES	Insulated ratchet wrench for clamp top	8 in (20.3 cm)	2 lb (0.91 kg)
4412R-ES	12 in Ratchet Wrench	-	-
1258HEQ-ES	Quick Change Handle	8 in (20.3 cm)	1 lb (0.45 kg)

LIVE LINE LEVER CUTTERS		
Item #	Size	Weight
	ft (m)	lb (kg)
3006FG-ES	6 ft (1.83 m)	11 lb (4.99 kg)
3008FG-ES	8 ft (2.44 m)	11 lb (4.99 kg)



44CFG-ES



3008FG-ES



## TRANSFORMER GIN ASSEMBLY & TOOL FRAME

### TRANSFORMER GIN ASSEMBLIES

Transformer Gin Assemblies are designed to lift transformers, cross arms and other items used in pole construction. Assembly consists of a pole with ferrules, top fitting, center fitting, base fitting and protective bag for the pole. Has a balanced or \*unbalanced safe working load limit of 2,500 lb (1,134 kg), at a minimum of 18 in apart. The working load limit (WLL) is the total load on the gin assembly including load to be lifted, pull on fall line and friction. Rope and block assembly not included.

### TOOL FRAME

The Tool Frame is a convenient place to hang tools when they are not in use, has swivel eye allowing the frame to rotate.

### ROPE-SNIBBING BRACKET

The Rope-Snibbing Bracket attaches to the pole and provides a safe place to tie lines or hook blocks when handling loads.

TRANSFORMER GIN ASSEMBLY			
Item #	Description	Weight	WLL
		lb (kg)	
112-ES	Transformer Gin Assembly	89 lb (40.36 kg)	2,500 lb
100T-ES	Tool Frame	1 lb (0.45 kg)	-
100TR-ES	Tool Frame with Rope and Snap	2 lb (0.91 kg)	-

ROPE-SNUBBING BRACKET			
Item #	Description	Weight	WLL
		lb (kg)	
8200-ES	Pole Type Bracket with Rings, Chain Length: 51 in (1.30 m)	10 lb (4.55 kg)	-
8200S-ES	Pole Type Bracket without Rings Chain Length: 51 in (1.30 m)	10 lb (4.55 kg)	-

**⚠ WARNING**  
Tagging loads working load limit subject gin to side loading that will reduce WLL.



100TR-ES



8200-ES



8200S-ES



112-ES

## TRANSFORMER GIN ASSEMBLIES

### TRANSFORMER GIN ASSEMBLY

The Transformer Gin Assembly is made from steel. Can be installed on the pole by one lineworker with the single alloy chain. The assembly can also be installed over a cross arm. Blocks can be installed in the eye or from the shackle provided. Rope guides for the fall line are located on both sides of the gin assembly. The gin assembly has a safe working load limit of 2,000 lb (907 kg).The safe working load limit is the total load on the gin assembly including load to be lifted, pull on fall line and friction.

### HEAVY DUTY TRANSFORMER GIN ASSEMBLY

The Heavy Duty Transformer Gin Assembly designed for easy installation on the pole with a 0.3125 in high test chain and tightening handle. The gin can also be installed over a cross arm. The assembly has a safe working load limit of 5,000 lb (2,268 kg). The safe working load limit is the total load on the gin assembly including load to be lifted, pull on fall line and friction.

GIN ASSEMBLY			
Item #	Description	Weight	WLL
		lb (kg)	lb
133-ES	Transformer Gin Assembly	25 lb (11.34 kg)	2,000 lb
1200SL-ES	Heavy Duty Transformer Gin Assembly	39 lb (17.73 kg)	5,000 lb

**⚠ WARNING**  
Tagging loads working load limit subject gin to side loading that will reduce WLL.



133-ES



1200SL-ES

## TEMPORARY SIDE ARMS & TRANSFER ARMS

### TEMPORARY TRANSFER ARM

The Temporary Transfer Arm is used to change crossarms, insulators or poles on short spans up to and including 15 kV phase to phase. The mast (Cat. No. 1306M) is 2.5 in diameter by 6 ft (1.82 m) long. The horizontal arm (Cat. No. 1340WHF8) is 2.5 in diameter by 8 ft (2.44 m) long. The arm has a balanced load rating of 600 lb (272 kg); unbalanced at 150 lb (68 kg).

### TEMPORARY SIDE ARM - POLE MOUNTED

The Temporary Side Arm - Pole Mounted holds energized conductors during replacement of poles and repair or replacement of insulators. It is made of 2.5 in (6.3 cm) diameter foam-filled fiberglass with removable and adjustable wire holders. Each arm has a strap hoist or chain binder. Specify length of arm and number of wire holders needed. Side arms without insulators are rated for 15 kV; with insulators, 35 kV. 8 ft side arm includes arm support. WLL: 4 ft (1.22 m) - 300 lb (136 kg)

### TEMPORARY SIDE ARM - CROSS ARM MOUNTED

The 6 ft (1.83 m) side-mounted Temporary Side Arm - Cross Arm Mounted has 2 wire holders and is used as a temporary conductor holder while replacing or repairing existing conductors or insulators. Made from 2.5 in diameter foam-filled fiberglass. Both wire holders are adjustable and removable. Units without insulators are rated for 15 kV and 35 kV with insulators.

WLL: 300 lb (136 kg) OR 150 lb (68 kg) PER WIRE HOLDER.

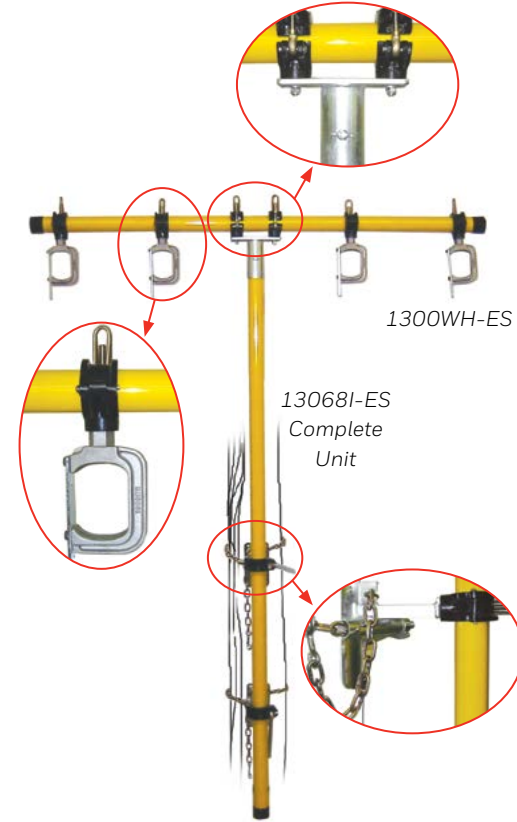

## CONDUCTOR & CLEANING TOOLS

Tubular brush es are preferred when rubber gloving or when working on de-energized conductors. The steel bristles are internal to prevent damaging rubber gloves. The 2.5 in (63.5 mm) tubular brush is used in confined areas such as between two connectors or clamps.

The "V" type wire brush es are available with epoxy-coated handle or universal attachment that can be used with hotsticks. Replacement brushes are available.

CONDUCTOR & CLEANING TOOLS		
Item #	Description in. (mm)	Weight Ea lb (kg)
4110-ES	5 in (127 mm) Universal tubular	1.3 lb (0.6 kg)
4112-ES	"V" type handle with brushes	1.2 lb (0.6 kg)
4337-ES	2.5 in (63.5 mm) tubular	0.2 lb (0.1 kg)



4110-ES



4112-ES

TEMPORARY SIDE ARMS & TRANSFER ARMS		
Item #	Description	Weight
		lb (kg)
13068I-ES	Temporary Transfer Arms w/Insulators	65 lb (29.48 kg)
1300WH-ES	Wire Hanger wo/Insulators	3 lb (1.36 kg)



### DESIGN

Unibody design insulators are one-piece injection molded directly to the rod and sealed to the end fittings with a bead of silicone to give the insulator high dielectric strength and protect it from all environmental conditions. This design is used for standard distribution dead end/suspension insulators.

### FIBERGLASS ROD

A high quality fiberglass reinforced rod is the core of every insulator with ultimate mechanical strength at least twice the maximum working load.

### END FITTINGS

Standard distribution dead/end suspension units are supplied with clevis and tongue fittings meeting ANSI C29 specifications. Ball, socket and eye fittings are also available. All are made of hot dipped galvanized high strength carbon steel and have an ultimate tensile strength rating of 15,000 pounds. All end fittings on dead/end suspension insulators are attached by compression. Every insulator is proof tested to verify the crimp.

*Unibody insulators have end fittings sealed with silicone to eliminate any possibility of moisture or contamination from reaching the fiberglass rod.*

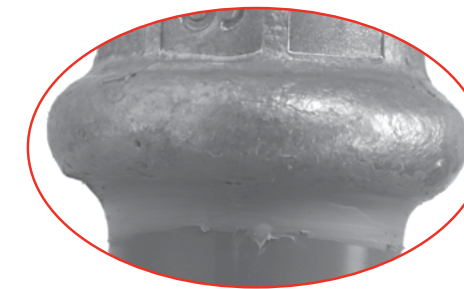

### INSULATORS SPECIFICATIONS

Dimensions				
Rated Voltage		15 KV	25 KV	35 KV
Section Length		345 mm ±15 mm	430 mm ±35 mm	525 mm ±55 mm
Leakage Distance		430 mm	640 mm	850 mm
Minimum Arcing Distance		210 mm	301 mm	398 mm
Electrical Ratings				
Low Frequency Flashover	Dry	100	131	166
Voltage Test (60 Hz)	Wet	82 kV	111 kV	138 kV
Critical Impulse Flashover	Positive	159	221	279
Voltage Test	Negative	185 kV	251 kV	320 kV
Radio Influence Voltage Data	Max. Voltage	< 1 μV	< 1 μV	< 1 μV
Mechanical Ratings				
Failing Load Test		> 7000 KG	> 7000 KG	> 7000 KG
Number of Sheds		4	6	8

# INSULATORS

## SILICONE COMPOSITE INSULATORS

We combine the technologies of a fiberglass reinforced rod, metal fittings and our extensive knowledge of elastomeric insulation to produce a high quality composite insulator. Since 1980, thousands of silicone insulators have been installed by utilities worldwide in a variety of environments. Continued outstanding performance is proof of their superior quality and design.

### SI SERIES SILICONE INSULATOR

Featuring a silicone formulation weathershed material. Salisbury combined the excellent hydrophobic and electrical qualities of silicone with an optimum weathershed design and corrosion resistant fiberglass rod to produce a state-of-the-art insulator which meets or exceeds industry requirements. The insulators were tested in accordance with ANSI C29 and IEC1109. End fittings are hot dipped galvanized high strength carbon steel, providing a 15,000 pound ultimate tensile strength. 100% proof testing ensures trouble-free installation. **RUS Accepted.**

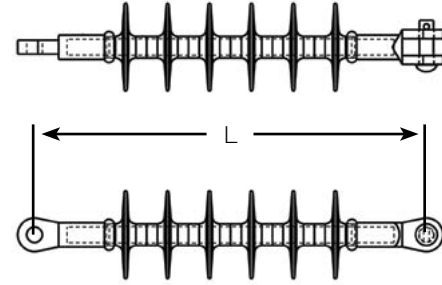

SI SERIES INSULATORS SPECIFICATION			
	9501U-SI-ES	9502U-SI-ES	9503U-SI-ES
<b>Class</b>	DS-15	DS-28	DS-35
<b>Number of weathersheds</b>	4	6	8
<b>Length</b>	13.5 in (0.34 m)	17.5 in (0.45 m)	21.3 in (0.54 m)
<b>Diameter of weathersheds</b>	3.8 in (97 mm)	3.8 in (97 mm)	3.8 in (97 mm)
<b>Leakage distance</b>	17.1 in (0.44 m)	26 in (0.66 m)	35.1 in (0.89 m)
<b>Dry arc distance</b>	8.4 in (0.22 m)	12.13 in (0.31 m)	16 in (0.41 m)
<b>Flash over voltage</b>	Critical impulse, positive	173	217
	Critical impulse, negative	250	310
	Dry, 60 Hz	97	145
	Wet, 60 Hz	67	115
<b>Radio influence</b>	Test, kV ground	15 kV	25 kV
	Max RIV-1000 kHz $\mu$ V	1	1
<b>Ultimate strength</b>	15,000 lb	15,000 lb	15,000 lb
<b>FRP rod diameter</b>	0.73 in (18,63 mm)	0.73 in (18,63 mm)	0.73 in (18,63 mm)
<b>Typ. Appl-kV, Ø-Ø</b>	15	27	35
<b>Net weight</b>	2.6 lbs (1.2 kg)	3.1 lbs (1.39 kg)	3.5 lbs (1.57 kg)

### 9502L-EP SILICONE INSULATOR

The 9502L-EP-ES Silicone Insulator combines two essential characteristics: Performance and Innovation. The 9502L-EP-ES is the only composite insulator manufactured as a replacement for two 10 in (254 mm) porcelain disks. Installation is limited to horizontal dead-end applications only. Unlike any other insulator on the market, the unique shed design of the 9502L-EP-ES minimizes the material content without compromising electrical or dimensional requirements. End fittings are hot dipped galvanized high strength carbon steel. Must be used as a dead end insulator only.

**RUS Accepted.**

SPECIFICATIONS		9502L-EP-ES
<b>Number of weathersheds</b>		4
<b>Length</b>		11.5 in (0.29 m)
<b>Diameter of weathersheds</b>		5 in (127 mm)
<b>Leakage distance</b>		22 in (0.56 m)
<b>Electrical</b>	Critical impulse	189
<b>Ratings</b>	Dry, 60 Hz	116
<b>kV</b>	Wet, 60 Hz	92
<b>Radio</b>	Test, kV ground	20 kV
<b>Influence</b>	Max RIV-1000 kHz $\mu$ V	1
<b>Typ. appl-kV, Ø-Ø</b>		27
<b>Ultimate strength-SML</b>		15,000 lbs (70 kN)
<b>Net weight</b>		2.8 lbs (1.3 kgs)

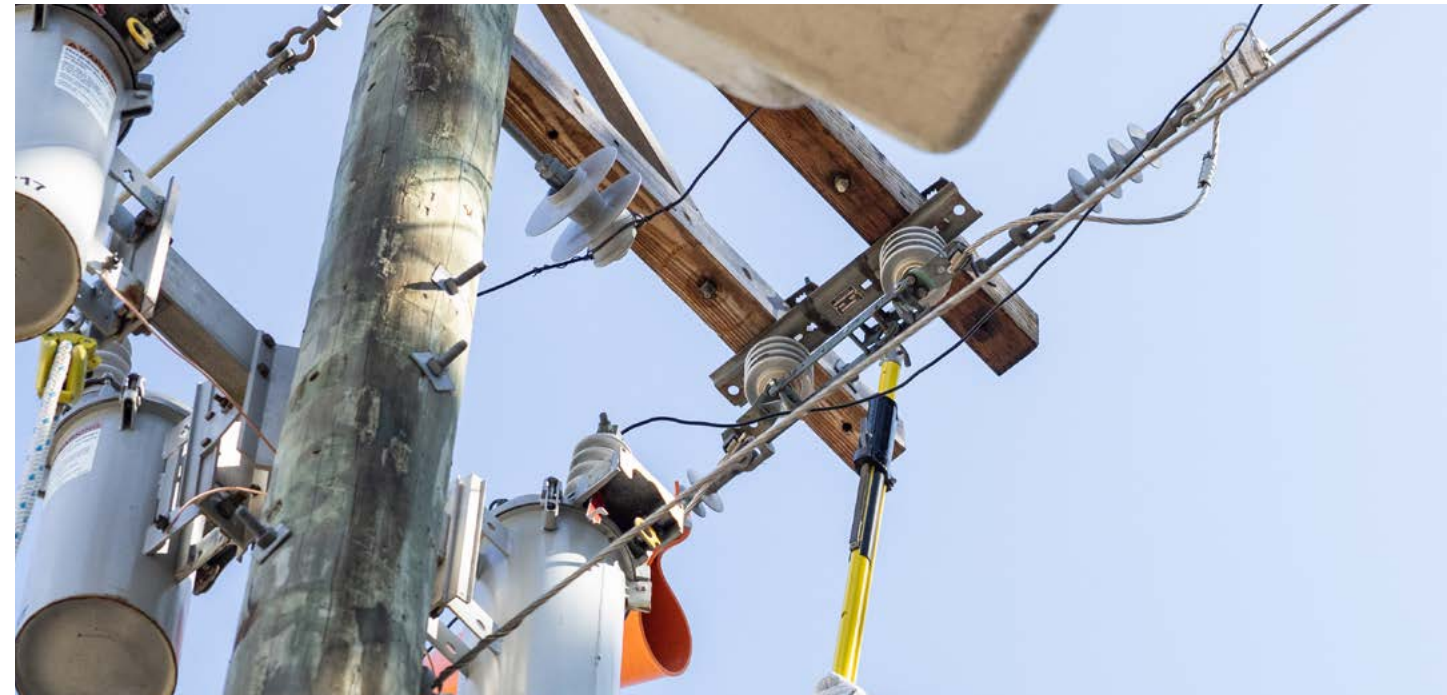
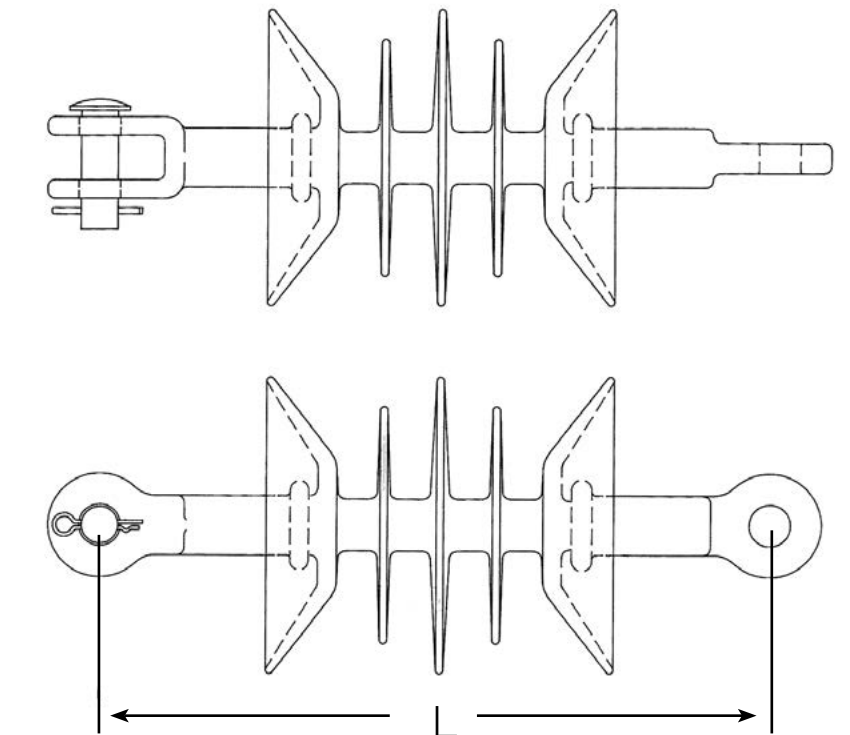
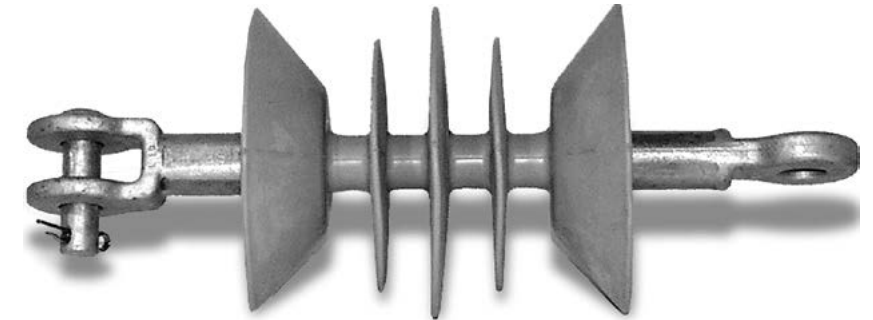



### SALISBURY ADVANTAGE

Insulated bypass jumper sets consist of three basic components: one pair of clamps, one pair of ferrules and a length of insulated cable. On the following pages, the most popular jumper sets are listed with the types of jumper clamps in which they are associated. When a custom jumper is required, follow this procedure to ensure that a complete and functional jumper is specified.

If you quickly need assembled jumper sets, please contact your local Salisbury Representative for more information. Let Salisbury professionally assemble your sets for you.

All Salisbury Insulating Jumpers meet ASTM F2321 standards.

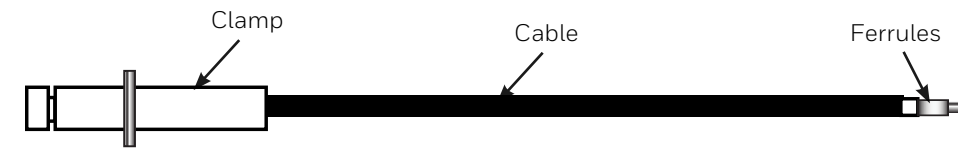

### INSULATED JUMPER CHECKLIST

1. Specify the style of insulated clamps. All of the clamps are hand installed wearing rubber insulating gloves, accept either shrouded or unshrouded ferrules and accept insulated cable up to 4/0, 35 kV. Insulated jumper clamps are sold in pairs.
2. Specify the size and length of insulated cable. Salisbury offers 15 kV cable from #2 to 4/0. 25 kV and 35 kV cable are both available in sizes 1/0 and 2/0. Be sure to specify the length of the cable chosen.
3. Specify the size and style of ferrules required. The size of the ferrule will be determined by the size of the cable. Specify the appropriate ferrule catalog number for either shrouded or unshrouded ferrules. Both types are sold in pairs.
4. Specify if the jumpers are to be factory assembled. A complete jumper set with crimped ferrules and installed jumper clamps will be supplied. Salisbury has state-of-the-art, computer-controlled crimping available.
5. Specify if there are any special requirements. This could include heat shrink tubing, special assembly instructions,

# INSULATED JUMPERS

## SURE-LOK® CLAMP

Loose jumper clamps not only jeopardize your safety but can also cause fires and power outages. Even when torqued using wrenches or pliers, traditional clamps will eventually loosen from line vibrations. This clamp tightens with a ratchet action using one hand, with no extra tools, for a secure and positive connection. When you want to loosen or remove the jumper clamp, simply pull and turn the locking knob and it will loosen like a traditional clamp.

## FAQ

Q: What are the benefits of the Sure-lok® Jumper clamp?

A: The Salisbury Sure-lok® Jumper clamp is an improvement over other jumper clamps available. The Sure-lok® features a ratchet-type locking mechanism which guarantees the clamp not to loosen once it is installed on a line.

## SURE-LOK® JUMPER CLAMPS & SALCOR® INSULATED JUMPER CLAMPS

### SALCOR® JUMPER CLAMPS

The Salisbury Sure-lok® Jumper Clamp is a revolutionary improvement and features a ratchet type locking mechanism.

Loose jumper clamps not only jeopardize your safety but can also cause fires and power outages. This clamp tightens with a ratchet action using one hand, with no extra tools for a secure, positive connection. It can't come loose until you want it to. Pull and turn the locking knob and it loosens like any traditional clamp.

Available in our exclusive SALCOR® material and the industry's most durable single piece clear plastic jumper clamps.

### SALCOR® JUMPER CLAMPS

SALCOR® Jumper Clamps are available in two main line sizes with a maximum use voltage of 35 kV.

The SALCOR® Jumper Clamp not only provides a superior grip, but also resists ozone cutting and tracking. Being molded of rubber, these handles are inherently impact resistant and extremely durable. The body and jaw are made from a copper base alloy. The lower ring contact is made of self lubricating bronze. Assemble jumpers with insulated jumper cable and 5/8 in- 11 NC threaded ferrules. Assembled kits are sold with a 10 ft (3 m) cable and unshrouded ferrules.

Custom built assemblies are available. Contact your local Salisbury representative for more information.



1786-ES

2261-ES  
SALCOR®  
Sure-lok®



2260-ES

2270-ES

## CLEAR PLASTIC & FRP INSULATED JUMPER CLAMPS

### SALISBURY CLEAR JUMPER CLAMPS

Salisbury's superior stress cracking-resistant clear jumper clamps are available in two main line sizes with a maximum use voltage of 35 kV. Assemble these clamps with insulated jumper cable and 5/8 in - 11 NC threaded ferrules.

### CLEAR PLASTIC JUMPER CLAMPS

Clear plastic jumper clamps are compact, lightweight, and virtually unbreakable. The transparency allows easy inspection of the ferrule and cable inside of the handle. The body and jaw are made from a copper base alloy. The lower floating ring contact is bronze. These handles should be cleaned only with a mild detergent to maintain the transparency of the handle. Assembled kits are sold with a 10 ft (3 m) cable and unshrouded ferrules.

### FRP JUMPER CLAMPS

FRP Jumper Clamps are designed for maximum loads, voltages and cables. During a temperature rise test at 25% overload, these clamps heated 35% less than 4/0 cu. cable. Blunted points on the handle provide optimum grip, resist impact and will not soften with overloads. The body and jaw are made from a copper based alloy. The lower jaw is made of self lubricating bronze. The assembled jumpers are sold with a 10 ft (3 m) or 12 ft (3.7 m) cable and unshrouded ferrules.

Custom built assemblies are available. Contact your local Salisbury Representative for more information.



Clear jumper  
with cable

2115-ES



1610-ES

1785-ES

SURE-LOK® JUMPER CLAMPS & SALCOR® INSULATED JUMPER CLAMPS						
Item #	Description	Main Line Range	Max. Amps Continuous	Rating	OAL Length in (mm)	Weight ea. lb (kg)
2261-ES	SALCOR® Sure-lok® Jumper Clamp	477 MCM (0.9 in to 0.162 in)	400	36 kV Ø-Ø, 21 kV Ø-GRD	11.5 in (292 mm)	10 lb (4.5 kg)
1786-ES	Clear Plastic Sure-lok® Jumper Clamp	477 MCM (0.9 in to 0.162 in)	400	36 kV Ø-Ø, 21 kV Ø-GRD	11.5 in (292 mm)	8 lb (3.6 kg)
2116-ES	Clear Plastic Sure-lok® Jumper Clamp	954 MCM (0.25 in to 0.162 in)	400	36 kV Ø-Ø, 21 kV Ø-GRD	11.5 in (292 mm)	10 lb (4.5 kg)
2260-ES	SALCOR® Jumper Clamp	477 MCM (0.9 in to 0.162 in)	400	36 kV Ø-Ø, 21 kV Ø-GRD	11.5 in (292 mm)	10 lb (4.5 kg)
2270-ES	SALCOR® Jumper Clamp	954 MCM (0.25 in to 0.162 in)	400	36 kV Ø-Ø, 21 kV Ø-GRD	11.5 in (292 mm)	11 lb (5 kg)

10 FT (3 M) ASSEMBLED JUMPER SETS WITH 2260 CLAMPS					
Item #	Cable Size	Cable Cat. No.	Ferrule Cat. No.	Max. Amps Continuous	Weight ea. lb (kg)
2264-ES	#2-15 kV	2754	2022	200	10.9 lb (4.9 kg)
2266-ES	2/0-15 kV	2756	2024	300	14.8 lb (6.8 kg)
10 FT (3 M) ASSEMBLED JUMPER SETS WITH 2270 CLAMPS					
2276-ES	2/0-15 kV	2756	2024	300	15.9 lb (7.2 kg)

CLEAR PLASTIC & FRP INSULATED JUMPER CLAMPS						
Item #	Description	Main Line Range	Max. Amps Continuous	Rating	OAL Length in (mm)	Weight ea. lb (kg)
1610-ES	FRP Jumper Clamp	954 MCM (1.25 in to 0.162 in)	400	36 kV Ø-Ø, 21 kV Ø-GRD	11 in (279 mm)	14 lb (6.4 kg)
1785-ES	Clear Plastic Jumper Clamp	477 MCM (0.9 in to 0.162 in)	400	36 kV Ø-Ø, 21 kV Ø-GRD	11.5 in (292 mm)	8 lb (3.6 kg)
2115-ES	Clear Plastic Jumper Clamp	954 MCM (1.25 in to 0.162 in)	400	36 kV Ø-Ø, 21 kV Ø-GRD	11.5 in (292 mm)	10 lb (4.5 kg)

## FLEXIBLE INSULATED JUMPER CABLES, STICK INSTALLED FLEXIBLE JUMPER CLAMPS & FERRULES

### FLEXIBLE INSULATED JUMPER CLAMPS

Flexible insulated jumper cables are lightweight and resistant to oil, heat, moisture, ozone and abrasion. The cable is embossed every three feet with the conductor size and kV rating.

All jumper cables use fine stranded conductor and a new EPR low temperature unipass orange CV cured jacket. The fine stranded copper conductor is alloy coated and assembled in a unidirectional rope lay for extra flexibility. The conductor has a semiconducting shield surrounding it to relieve voltage stress and improve dielectric strength and service life.

Cable meets requirements of ASTM F2321.

### STICK INSTALLED FLEXIBLE JUMPERS

Stick installed flexible jumpers can be manufactured for hotstick operations using Salisbury heavy-duty eye clamps. Clamps are rated for continuous current and fit all standard shotgun type hotsticks. For ease of application, a Hanger Stud is recommended. Shrouded ferrules are not recommended for use with eye type clamps.

Custom built assemblies are available. Contact your local Salisbury representative for more information.

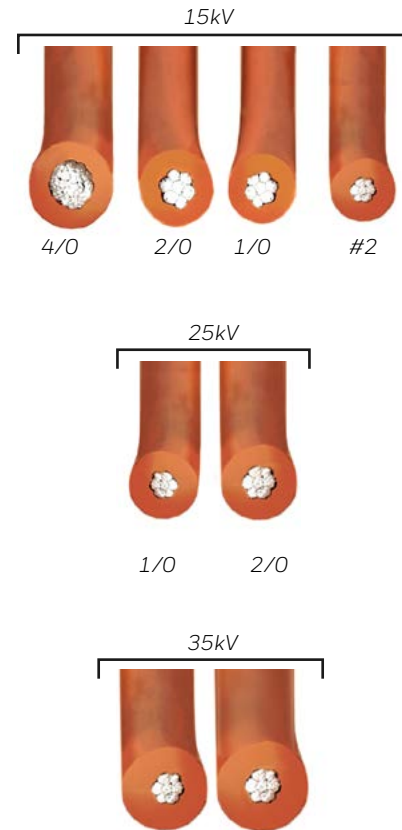

## INSULATED JUMPER CLAMP ACCESSORIES

### STIRRUP CLAMPS

Stirrup Clamps are used to convert a hand installed jumper into a stick installed jumper. The stirrup is designed to accept all conventional jumper heads.

### HOT JUMPER PARKING STAND

The Hot Jumper Parking Stand safely holds either glove or stick installed hot bypass jumpers. This insulated tool removes the risk of accidental contact with the uninstalled end of an energized jumper. Installs by hand using rubber insulating gloves or with a standard shotgun stick. The fiberglass jumper hanger bar will accommodate standard size mechanical jumper heads.

### CONNECTOR LINK

The Connector Link connects two insulated jumpers to create a longer jumper length. After the two clamps are connected to the link, the assembly can be wrapped with a small rubber insulating blanket.



### INSULATED JUMPER CLAMP ACCESSORIES

Item #	Main Line Range	Description	Max. Amps Continuous	Weight Ea. lb (kg)
2750-ES	—	Connector Link	400	0.3 lb (0.1 kg)
21123RG-ES	1033 MCM ASCR to #6 Sol., 1.25 in to 0.16 in (32 mm to 4.1mm)	Hot Jumper Stirrup Clamp	400	3 lb (1.4 kg)
4245-ES	954 MCM ACSR to #6 Sol. 1.14 in to 0.16 in (29 mm to 4.1 mm)	Parking Stand for Hot Jumpers	n/a	3.5 lb (1.6 kg)

FLEXIBLE INSULATED JUMPER CABLES							
Item #	Size & Str. AWG	kV Rating Ø to Ø	Nominal Ø to Grid	Str. Dia. in (mm)	OAL Length in (mm)	Max. Amps Continuous	Weight per 1000 ft lb (kg)
2754-ES	#2-259W	15	10	0.320 in (8.1 mm)	0.75 in (19 mm)	200	440 lb (199 kg)
2755-ES	1/0-413W	15	10	0.403 in (10.2 mm)	0.83 in (21 mm)	250	600 lb (272 kg)
2756-ES	2/0-427W	15	10	0.456 in (11.5 mm)	0.90 in (23 mm)	300	710 lb (322 kg)
2757-ES	4/0-437W	15	10	0.592 in (15 mm)	1.01 in (25.6 mm)	400	1050 lb (476 kg)
21060-ES	2/0-427W	25	15	0.456 in (11.5 mm)	1.10 in (28 mm)	300	750 lb (341 kg)
2059-ES	1/0-413W	35	20	0.403 in (10.2 mm)	1.22 in (31 mm)	250	950 lb (431 kg)
4370-ES	2/0-427W	35	20	0.48 in (12.1 mm)	1.31 in (33.1 mm)	300	1060 lb (482 kg)



## VOLTAGE DETECTION APPLICATION CHART

Detector setting	System Voltage - (Phase to Phase/Phase to Ground)																		
	4160 2400	8320 4800	12000 69300	12470 7200	13200 7620	13800 7970	20780 12000	22860 13200	24940 14400	34500 19920	46000 26560	69000 39840	115000 66400	138000 79670	161000 92950	230000 132790	345000 199190	500000 288680	
240 v	Green	Green	Green	Green	Green	Green	Green	Green	Green	Green	Green	Green	Green	Green	Green	Green	Green	Green	Green
4.2 kv	Green	Green	Green	Green	Green	Green	Green	Green	Green	Green	Green	Green	Green	Green	Green	Green	Green	Green	Green
15 kv	Red	Yellow	Green	Green	Green	Green	Green	Green	Green	Green	Green	Green	Green	Green	Green	Green	Green	Green	Green
25 kv	Red	Yellow	Yellow	Yellow	Yellow	Yellow	Green	Green	Green	Green	Green	Green	Green	Green	Green	Green	Green	Green	Green
35 kv	Red	Red	Yellow	Yellow	Yellow	Yellow	Yellow	Yellow	Yellow	Green	Green	Green	Green	Green	Green	Green	Green	Green	Green
46 kv	Red	Red	Red	Yellow	Yellow	Yellow	Yellow	Yellow	Yellow	Yellow	Green	Green	Green	Green	Green	Green	Green	Green	Green
69 kv	Red	Red	Red	Red	Red	Red	Red	Yellow	Yellow	Yellow	Yellow	Green	Green	Green	Green	Green	Green	Green	Green
115 kv	Red	Red	Red	Red	Red	Red	Red	Red	Yellow	Yellow	Yellow	Yellow	Green	Green	Green	Green	Green	Green	Green
230 kv	Red	Red	Red	Red	Red	Red	Red	Red	Red	Red	Red	Red	Yellow	Yellow	Green	Green	Green	Green	Green
345 kv	Red	Red	Red	Red	Red	Red	Red	Red	Red	Red	Red	Red	Red	Red	Yellow	Yellow	Yellow	Yellow	Green
500 kv	Red	Red	Red	Red	Red	Red	Red	Red	Red	Red	Red	Red	Red	Red	Red	Yellow	Yellow	Yellow	Green
URD TEST POINTS ONLY																			
15 kv URD	Red	Yellow	Yellow	Green	Green	Green	Green	Green	Green	Green	Green	Green	Green	Green	Green	Green	Green	Green	Green
25 kv URD	Red	Red	Yellow	Yellow	Green	Green	Green	Green	Green	Green	Green	Green	Green	Green	Green	Green	Green	Green	Green
35 kv URD	Red	Red	Red	Yellow	Yellow	Yellow	Yellow	Yellow	Yellow	Green	Green	Green	Green	Green	Green	Green	Green	Green	Green

- GREEN - Recommended for use.**  
The cells highlighted in green identify appropriate detector settings for a given system voltage.
- YELLOW - Suitable for use only under special circumstances..**  
The cells highlighted in yellow may be used in special circumstances. These circumstances may include the detection of voltage on an underbuilt circuit with induced voltage sufficient to cause a detection alarm. For example: In the 25kV setting the tester may not detect lower voltages at the required 8 to 10 inches from the conductor. However it may detect lower induced voltage, e.g. 5 kV at 1in from the conductor.
- RED - Never select a detector setting indicated by a red cell for a given system voltage.**  
The detector may not indicate voltage present and serious injury or death may result.

The above matrix identifies Honeywell Salisbury Models 4244-ES, 4544-ES, 4344-ES, 4644-ES, 4444-ES, 4744-ES, voltage detector applications settings for given system voltage. By selecting a detector voltage higher than the system voltage setting, the sensitivity of the detector is reduced and it may not detect the system voltage tested. Always install an appropriate grounding system before working on any conductors.

# VOLTAGE DETECTORS

### FAQ

**Q:** Are there any precautions, besides wearing the proper safety equipment, when using voltage detectors?

**A:** Yes, do not assume conductors that have been tested de-energized will stay de-energized. Always install proper grounding devices before working. Failure to do so may result in serious injury or death.



## SELF-TESTING AUDIO/VISUAL

### SELF TESTING VOLTAGE DETECTOR KITS

Salisbury's self-testing voltage detectors allow testing to be continuous and automatic. An intermittent flash and beep confirms the detector is functioning properly.

Self-testing voltage detectors are used to verify live or de-energized conductors. These detectors may be used with insulating rubber gloves or hotsticks using the splined universal end fitting. Testers indicate voltage with an extra bright LED light and a distinctive audible signal. It is recommended that the tester be moved closer to the conductor until a warning is indicated, or it touches the conductor, apparatus or test point. Each tester includes three "C" batteries.

The need for additional PPE can be minimized by confirming that there is no electrical hazard present before work is performed. This can be determined by using a Salisbury voltage detector attached to a insulating hotstick of a length long enough to keep the worker outside of the arc flash boundary.

The Salisbury voltage detector alarms in the proximity of electric fields, so that it is not necessary to make physical contact with the equipment being checked. It is made of non-conductive materials, meaning that it will not conduct electricity nor will it cause an arc flash, even if contact with energized equipment is made.



**⚠ WARNING**  
Do not assume conductors that have been tested de-energized will stay de-energized. Always install proper grounding devices before working. Failure to do so may result in serious injury or death.

## AUDIO/VISUAL

Voltage Detectors are used to verify live or de-energized conductors. These detectors may be used with rubber insulating gloves or hotsticks using the splined universal end fitting. Testers indicate the presence of voltage with an extra bright LED light and a distinctive audible signal. It is recommended that the tester be moved closer to conductor until warning is indicated, or it touches conductor, apparatus or test point. Test the unit on a nearby energized conductor. Each tester requires three "C" batteries (included).

### 4445 VOLTAGE DETECTOR TESTER

The 4445 Voltage Detector Tester provides the most convenient and reliable means of verifying operation of Salisbury Voltage Detectors. The tester features instant push-button operation and requires a standard 9-volt battery (included). It's portable and lightweight. To operate, push the button and move the tester toward the voltage detector being verified. The tester generates an electric field that activates the detector verifying the audible and visual signals are operational.

**TEST PROCEDURES**

To assure unit is in operable condition switch tester into "Test-240V" position. The detector may now be tested in several different ways.

1. Place head as marked against live wire outlet or equivalent above 110 V.A.C.
2. Rub the head as marked on cloth or clothing to obtain static charge. Unit will only indicate intermittently.

**⚠ WARNING**  
Do not assume conductors that have been tested de-energized will stay de-energized. Always install proper grounding devices before working. Failure to do so may result in serious injury or death.



VOLTAGE DETECTOR - SELF-TESTING			
Item #	Dimensions in (mm)	Settings Phase to Phase	Weight ea. lb (kg)
4544-ES	11 in x 3.5 in (279.4 mm x 89 mm)	Off / Test / 4.2 kV / 15 kV / 25 kV / 35 kV / 69 kV / 115 kV / 230 kV	1 lb (0.45) kg
4644-ES	11 in x 3.5 in (279.4 mm x 89 mm)	Off / Test / 4.2 kV / 35 kV / 69 kV / 115 kV / 230 kV / 345 kV / 500 kV	1 lb (0.45) kg
4744-ES	11 in x 3.5 in (279.4 mm x 89 mm)	Off / Test / Battery / URD 15 / URD 25 / URD 35 / 4.2 kV Overhead 15 / Overhead 25 / Overhead 35 / Overhead 46k / Overhead 69	2.21 lb (1 kg)
4745-ES	11 in x 3.5 in (279.4 mm x 89 mm)	Off / Test / Battery / URD 4.8 kV / 7.2 kV / 16 kV Overhead 2.4 kV / 4.2 kV / 8.3 kV / 8 kV / 13.8-7.2 / 12.5 kV / 14.4/25-16/27.6 kV / 44 kV	1 lb (0.45) kg
VOLTAGE DETECTOR - FULL KIT			
4556-ES	—	4544-ES Detector, Detector Case, Shotgun Adapter	3.53 lb (1.6 kg)
4667-ES	—	4644-ES Detector, Detector Case, Shotgun Adapter	3 lb (1.4 kg)
4769-ES	—	4744-ES Detector, Detector Case, Shotgun Adapter	3 lb (1.4 kg)

VOLTAGE DETECTOR TESTER			
Item #	Dimensions in (mm)	Settings Phase to Phase	Weight ea. lb (kg)
4244-ES	11 in x 3.5 in (279.4 mm x 89 mm)	Off / Test / 4.2 kV / 15 kV / 25 kV / 35 kV / 69 kV / 115 kV / 230 kV	2.21 lb (1 kg)
4344-ES	11 in x 3.5 in (279.4 mm x 89 mm)	Off / Test / 4.2 kV / 35 kV / 69 kV / 115 kV / 230 kV / 345 kV / 500 kV	1 lb (0.45) kg
4444-ES	11 in x 3.5 in (279.4 mm x 89 mm)	Off / Test / Battery / URD 15 / URD 25 / URD 35 Overhead 15 / Overhead 25 / Overhead 35 / Overhead 46 / Overhead 69	1 lb (0.45) kg
COMPLETE KIT			
4356-ES	—	4244-ES Detector, Detector Case, Shotgun Adapter	3.7 lb (1.67 kg)
4367-ES	—	4344-ES Detector, Detector Case, Shotgun Adapter	3.75 lb (1.7 kg)
4469-ES	—	4444-ES Detector, Detector Case, Shotgun Adapter	3 lb (1.4 kg)

ACCESSORIES			
2500-ES	—	Shotgun Adapter	0.4 lb (0.2 kg)
21517-ES	12 in x 8 in x 4.5 in (305 mm x 203 mm x 114 mm)	Storage Case	—
4445-ES	—	Voltage Detector Tester	2.21 lb (1 kg)
21600-ES	—	Replacement Handle	—

**For more information**

[www.burlingtonsafety.com](http://www.burlingtonsafety.com)

**Burlington Safety Laboratory, Inc.**

**Burlington, NJ**

6 Cooper St Unit 100  
Burlington, NJ 08016

(800)220-2120

**Westminster, CA**

7382 Bolsa Avenue  
Westminster, CA 92683

(800)296-2803

**Pleasanton, CA**

7087 Commerce Circle, Unit B  
Pleasanton, CA. 94588

(888)817-1412

email: [info@burlingtonsafety.com](mailto:info@burlingtonsafety.com)

Honeywell Salisbury 2024  
©2024 Honeywell International Inc.



**Honeywell**